



HANDBOOK

No. 07-34

Sep 07

PRT



Playbook



Tactics, Techniques, and Procedures

Center for Army Lessons Learned (CALL)
<http://call.army.mil>

U.S. UNCLASSIFIED



Foreword

Provincial reconstruction teams (PRTs) were established as a result of the need to develop the infrastructure necessary for the Afghan and Iraqi people to succeed in a post-conflict environment. The efforts of PRTs take place every day during a time when major conflict is commonplace in both countries. PRTs have become an integral part of the long-term strategy to transition the lines of security, governance, and economics to the indigenous people. Integrated appropriately, PRTs serve as combat multipliers for maneuver commanders engaged in governance and economics, as well as other critical lines of operation. In addition, PRTs serve as force multipliers for U.S. Government (USG) development agencies engaged across the stability and reconstruction sectors.

This playbook focuses on PRTs in general, with additional information specific to Iraq and Afghanistan. The information contained in this playbook comes from multiple sources inside and outside the USG with the understanding that the manner in which PRTs operate is likely to change over time.

The intent of this publication is to share knowledge, support discussion, and impart lessons and information in an expeditious manner. This Center for Army Lessons Learned (CALL) publication is not a doctrinal product. The information provided in this publication is written by USG employees for those individuals who will serve in a stability and reconstruction environment.

Acknowledgments: Special thanks to all the USG individuals who assisted the collection and presentation of this information. In particular, thanks to the interagency teams from Department of State, U.S. Department of Agriculture, U.S. Agency for International Development, and the U.S. Institute for Peace for providing invaluable assistance in gathering this information to share with PRT practitioners in training and in the field. Finally, thanks are also extended to members of CALL's collection teams and theater observers for providing updated field input.

A handwritten signature in black ink, appearing to read 'S. Mains', is positioned above the name and title of the signatory.

Steven Mains
Colonel, Armor
Director
Center for Army Lessons Learned

Provincial Reconstruction Team Playbook	
Table of Contents	
Chapter 1: Introduction	1
Chapter 2: Concept and Intent	3
Chapter 3: Principles	9
Chapter 4: Strategic Guidance and Authorities	13
Chapter 5: Implementing Strategy	15
Chapter 6: Management and Structure	23
Annex A: Support References	31
Section I: Stability	31
Section II: Reconstruction	36
Section III: Commanders' Emergency Response Program	42
Section IV: How to Operate as a Team	46
Section V: Information Sharing	49
Annex B: Afghanistan Provincial Reconstruction Teams	53
Annex C: Iraq Provincial Reconstruction Teams	61
Appendix 1: Extract of the Department of Defense/Department of State Memorandum of Agreement on Iraq PRTs	73
Appendix 2: Iraq Background Notes	89
Appendix 3: United Nations Assistance Mission for Iraq	93
Appendix 4: NATO's Assistance to Iraq	97
Appendix 5: Engagement With the Media	99
Appendix 6: Local Governance Program	101
Annex D: Best Practices	103

CENTER FOR ARMY LESSONS LEARNED

This publication is a living document and is posted on the CALL Web site, as well as on prtportal.org. Individuals may join in the discussion of PRT-related topics on prtportal.org and make recommended changes to the document. When appropriate, these discussion topics and changes will be reflected in the next iteration of the publication.

Center for Army Lessons Learned

The Secretary of the Army has determined that the publication of this periodical is necessary in the transaction of the public business as required by law of the Department.

CALL publications cover a variety of military topics. The views expressed in this CALL publication are those of the author(s) and not necessarily those of the Department of the Army or the Department of Defense. Unless otherwise stated, whenever the masculine or feminine gender is used, both are intended.

Chapter 1

Introduction

The higher goal of military and civil action is to win over the population, while killing the insurgents is a supporting or shaping effort. In other words, hostile individuals do not create hostile populations, rather, hostile populations will continue to create hostile leaders until the source of the hostility is alleviated.

A provincial reconstruction team (PRT) is an interim civil-military organization designed to operate in semi-permissive environments usually following open hostilities. The PRT is intended to improve stability in a given area by helping build the host nation's legitimacy and effectiveness in providing security to its citizens and delivering essential government services.

Military forces conduct complementary stability, offensive, and defensive activities as components of full-spectrum operations. Each campaign and major operation requires original and varying combinations of the components of full-spectrum operations appropriate to the situation. Full-spectrum operations are based on the continuous interaction between friendly forces; adversaries; all the U.S., international, and nongovernmental civilian agencies; host nation civil authorities concerned with the outcome; and the populations of areas affected. Civil authorities range from strategic-level leaders to local government officials to religious leaders. Affected populations may be of differing tribes or nations and of states on the periphery of the conflict.

Military forces must defeat enemies and simultaneously help shape the civil situation through stability operations. Shaping the civil situation in concert with other U.S. government agencies, international organizations, civil authorities, and multinational forces is important to campaign success. Stability operations may complement and reinforce offensive and defensive operations, or they may be the main effort of an operation. These operations may take place before, during, and after major combat operations and seek to secure the support of civil populations in unstable areas. Forces engaged in an operation predominated by stability tasks may have to conduct offensive and defensive operations to defend themselves or destroy forces seeking to challenge the stability mission. Following hostilities, forces conduct stability operations to provide a secure environment for U.S., coalition, multinational, and local civil authorities as they work to achieve reconciliation, rebuild lost infrastructure, and resume vital services.

The focus of these combined military and civil efforts is to diminish the means and motivations for conflict, while developing local institutions so they can take the lead role in national governance (provide basic services, foster economic development, and enforce the rule of law). Success depends ultimately on the host nation and on the interrelationship and interdependence of the ensuing dynamics:

- The legitimacy of the government and its effectiveness as perceived by the local population and the international community.
- The perceived legitimacy of the freedoms and constraints placed on the force supporting the government.

- The degree to which factions, the local population, and other actors accede to the authority of the government and those forces supporting the government.

There are times when hostilities continue to exist in many forms during stability-focused operations because of warlords, tribal competition, ethnic rivalries, outlaws, terrorists, or insurgents. This can leave areas of a country caught in the middle of the transition between major combat and relative stability. Combat operations are very much “on again/off again” across parts of the country, and there are areas that have not stabilized significantly and are at risk of “slipping back” if security forces are removed. However, moving these areas further along is beyond the expertise and capabilities of any one department or agency. The military can operate in these unstable areas but lacks development skills. Diplomatic and development agencies have these skills but are unable to operate in these areas using their traditional delivery mechanisms because of the instability. Therefore, this complex environment requires an integrated civilian-military operation focused on achieving sufficient stability to allow reconstruction and development to begin.

PRTs were devised in 2002 as a means to solve this problem. A PRT stabilizes an area through its integrated civilian-military focus. It combines the diplomatic, military, and developmental components of the various agencies involved in the stabilization and reconstruction effort. The PRT is designed to help improve stability by building up the capacity of the host nation to govern; enhance economic viability; and deliver essential public services, such as security, law and order, justice, health care, and education. Once the stability objectives have been fulfilled, PRTs can begin to dismantle and the traditional diplomatic and developmental programs will operate within their normal venues.

This playbook provides a knowledge base to individuals operating in, adjacent to, or in support of a PRT, enabling these individuals to work effectively as a team to achieve the purpose of the PRT and providing PRT members with shared operational guidelines and insights into PRT best practices.

Chapter 2

Concept and Intent

The provincial reconstruction team (PRT) concept envisions an integrated civil-military organization expanding the reach of the U.S. government (USG) and the wider international community assistance efforts from the environs of the capitol to the provincial level to the local community. A PRT is generally responsible for covering one province but may have responsibility for two or more provinces or a large segment of a single province.

The PRT does not act as an alternative to a host nation's government but rather seeks to improve the governing capacity of the host nation. PRTs perform a vital role in occupying the vacuum caused by a weak government presence and hence deter agents of instability. The PRT focuses on three elements of stabilization and reconstruction:

- Increase provincial stability through international military presence and assist in developing nascent host nation security and rule of law capacity.
- Assist the establishment and improvement of local government, including its connection to the central government and populace, by advising and empowering stakeholders and legitimate governing bodies, influencing “fence sitters,” and countering obstructionists and spoilers.
- Facilitate reconstruction at a pace that begins to:
 - Provide basic services.
 - Provide an economic system that supports the people.
 - Gain popular buy-in for change and support of representative government.
 - Ensure popular expectations for international assistance are met or abated.

The PRT is also not a development agency. The PRT's role is to ensure international efforts are in line with the host nation's development intentions and, in doing so, assess and act on the constraints to development. As the security environment improves, the PRT is intended to phase out as stabilization and reconstruction programs shift to longer-term development programs. The PRT ceases to exist when normal development operations can be carried out without its assistance. This evolution in execution of the PRT mission requires a change in focus and an increased number of civilians with core competencies to address the development aspects of stabilization and reconstruction.

Purpose

Operations are dynamic and may not progress in a linear manner. Different parts of a country may require different combinations of offensive, defensive, and stability operations to transition from violent conflict toward stability and ultimately to peace. Full-spectrum operations involve simultaneous combinations of offense, defense, and stability operations.

The components of full-spectrum operations are not considered phases. Commanders consider the concurrent conduct of the components of full-spectrum operations in every phase of an operation. As the operational focus shifts from predominantly offensive and defensive to predominantly stability tasks, operational gaps can exist that prevent the development of an indigenous capability and capacity that supports the country’s transition to peace. Areas of the country can get “stuck” in instability, and the danger exists that they may “slip back” into open hostilities if security forces are removed. Ideally, stability operations in these areas lay the groundwork for long-term transformational development efforts designed to ensure the area does not “slip back” into instability or violent conflict (see Figure 2-1 below).¹

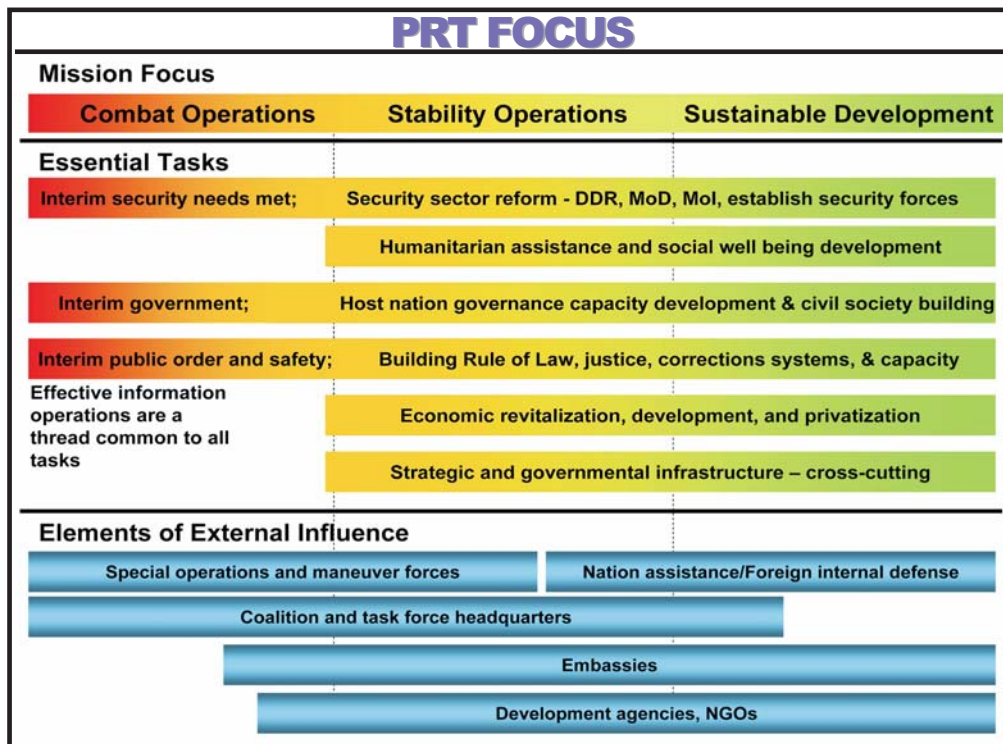

Figure 2-1: Spectrum of intervention

However, the operational gaps that lead to an area getting “stuck” in instability often exist because no actors aside from the military can operate in unstable areas. In order for the military to pass off responsibility for an area (i.e., exercise its exit strategy), it must deliver some level of stability. Moving these areas further along is beyond the expertise and capabilities of the military. While such expertise does reside in diplomatic and development agencies, these agencies are unable to operate in these areas using their traditional delivery mechanisms because of the instability.

PRTs were devised in 2002 as a mechanism that could solve this problem. Because of the combined capabilities of the diplomacy, military, and development components, PRTs are able to stabilize these areas. When the capabilities brought by the military component of the PRT are no longer needed, the military component can withdraw, and the diplomatic and development components can revert to more traditional means to pursue their aims. This process is gradual. PRTs in more unstable areas may require the capabilities of the military component for longer

periods of time. In stable areas, where security is sustainable by the local government and civilian agencies are capable of accomplishing their tasks without military assistance, PRTs can and should begin to draw down their military component.

The PRT is neither a combat nor a development institution. A PRT may perform combat and development in the pursuit of stability, but these activities are not the goal of the PRT.

The PRT is an interim structure designed to help improve stability by building up the capacity of the host nation to govern; enhance economic viability; and deliver essential public services, such as security, law and order, justice, health care, and education. Once the PRT stability objectives have been fulfilled, its mission is complete, and the PRT structure can be dismantled.

PRTs are extremely expensive in terms of personnel, maintenance, and activity costs. Therefore, it is incumbent on the embassy country team, military chain of command, troop contributing nations, participating agencies, and PRT leadership teams to keep PRTs focused on their ultimate goal and avoid all activities that do not directly contribute to accomplishing their mission.

Intent

Once the PRT is established, the first requirement is to gain access to local power centers and assess the environment to determine the issues that the PRT should address, as well as the challenges and obstacles impacting on these issues. A PRT plan is developed to achieve desired effects within the environment. The civil-military team, using the core competencies provided by Department of State, Department of Defense, U.S. Agency for International Development, and other agencies, should complete both assessment and strategy development. An implementation plan guided by the provincial stability strategy is then developed based on a realistic time frame for the anticipated tenure of the PRT and the dynamics of the area of responsibility (AOR).

The implementation plan continues to be adjusted by successive leaderships based on the changing nature of the AOR. The plan should account for national strategies including USG, international, host government, and work being done in adjacent provinces or regions. The optimal situation is to have a plan, owned and at least in part drafted by the PRT's local interlocutors, that supports a local strategy for the province. The assessment, strategy, and implementation plan should be reviewed and refined at regular intervals by the civil-military team.

This process ensures that the civil-military team achieves a common operating picture of the AOR and a common vision on how to affect the environment, which in turn provides for unity of effort within the PRT. The PRT determines its resource needs based on the assessment and the subsequent plan it develops. PRT leaders should identify issues that are beyond their capacity to successfully affect and request assistance, as necessary, from the embassy country team, higher military headquarters, or both. In addition, they should review how their plan will support or enhance national programs either by providing information or by facilitating implementation of national-level assistance.

Objectives

Execution of the mission should be designed around reaching the objectives; designated tasks and intent provided in higher-level direction; and the implementation of activities designed, in part or in whole, to achieve the effects necessary to attain PRT objectives. In general, most objectives will require efforts across multidisciplinary programs. For instance, achieving a desired effect may require: 1) political leverage on the government (local and/or central); 2) economic or development projects to mitigate the impact of a desired outcome; or 3) increased USG security presence or support to host nation forces to deter potential violence. Given the integrated capacity of a PRT, they are well-situated and should be fully resourced to achieve the following objectives:

- **Improve stability.** Determine the causes and means of conflict including resource competition, tribal/ethnic clashes, insurgency, criminal elements, and political instability; identify the triggers or opportunities to instigate conflict; determine ways to affect the causes and triggers; identify ways to mitigate or resolve the conflict; increase capacity of civil society and legitimate traditional processes to adjudicate and deter conflict.
- **Increase local institutional capacity.** Build individual, organizational, and structural capacity to provide public safety and basic services; where relevant, tie legitimate informal governance (traditional) leaders to nascent formal government organizations; tie appropriate reconstruction and stability projects to legitimate governing bodies.
- **Facilitate reconstruction activities.** Develop job creation programs for infrastructure activities; provide micro lending as soon as practicable; tie road improvements to commercial as well as political integration; and create value-added facilities to improve agriculture and natural resource capabilities within the local absorptive capacity.
- **Execute a strong strategic communications program.** Expand local information dissemination capacity, especially by local institutions (remember that actions speak louder than words); take advantage of face-to-face communication (where traditional and expected); get provincial leaders and authorities out to see district population and traditional leaders; tie reconstruction activities to legitimate governing bodies.

End State

The end state of a PRT occurs when the host nation's provisions for security and public safety are sufficient to support traditional means of development, and political stability is sustainable after the withdrawal of international forces. The PRT should design measures of effectiveness that delineate the perception of safety, the reduction of security incidences that impact daily life, the capacity of the government to provide basic services and rule of law, and the popular acceptance of legitimate formal and informal organizations and leaders by both the majority of the population and disaffected elements of the population.

Endnote

¹ Each PRT is at a different place on the spectrum of intervention, so the activities of each PRT must be wholly dependent upon local conditions.

Chapter 3

Principles

Focus on Stability

As stated in the previous chapter, the missions and objectives of the provincial reconstruction team (PRT) are based on the environment in which the PRT is operating. However, stability must be a key aspect of any PRT mission statement. Though context and constraints of the environment remain dynamic, only by achieving a specific level of stability will the PRT be able to “exit” and more traditional actors take its place. (See Annex A for a discussion on stability.)

Fill the Gaps

PRTs were created, in part, because of the lack of local capacity within government and traditional governing bodies, remote populations, and geographic areas that are politically unstable yet vital. As local governance structures, traditional authorities, intergovernmental organizations, the private sector, and other entities gain capabilities and effectiveness, the responsibilities of the PRT will shift and potentially shrink to mentoring, advising, and training. In the interim, the PRT will do everything that is not being done by these other entities to advance stability, short of being the government. It is extremely important to link all PRT actions to governing bodies and local institutions as much as possible. Balance is the key; it may be preferable to have a local solution that is less optimal than a PRT solution.

Coordinate and Integrate

As host nation governing bodies gain capacity and effectiveness, the PRT should cede responsibility for what has to be done. Similarly, the PRT should seek to create conditions that allow these other entities to continue to increase their capacity, effectiveness, and presence. To do this effectively and efficiently, the PRT should coordinate and integrate with the goals, plans, strategies, and activities of all stakeholders at all levels of government, civil society, private sector, traditional governance structures, intergovernmental organizations (IGOs), and nongovernmental organizations (NGOs). At times, this process may conflict with the desire to achieve quick results and successes.

Focus on Effects not Outputs

As with any diplomatic, defense, or development institution, there is a danger that PRTs may fall prey to pressure to deliver immediate but inappropriate proxy indicators of progress, including number of projects completed or quantity of funds expended. Perhaps what is not so clear is that some indicators that are considered effects within the development community are really only outputs for a PRT. For example, the development community may consider an increase in literacy or a decrease in child mortality to be an effect. However, for the PRT, these are outputs that are only important in so much as they forward the ultimate effect of stability.

Unity of Effort

Unity of effort requires coordination and cooperation among government departments and agencies, with NGOs and IGOs, among nations in any alliance or coalition, and with the host nation. Unity of effort in an operation occurs vertically and horizontally for all involved chains of command. Its source is the nation's will, and it flows to individuals at the point of activity. Without unity of effort, the probability of success for any endeavor is diminished.

Within the PRT there are often various agencies with differing mandates who are generally comfortable with their way of doing business. There is considerable potential for friction and competing agendas. If not directly addressed and managed by the PRT leadership and its higher management authority, the results may hinder the process, delay completion of objectives, or contribute to total failure of the mission.

The integration and alignment of civilian and military efforts is crucial to successful stability and reconstruction operations. PRTs must focus on supporting the host nation's government (local and national) and the populace across the stabilization and reconstruction sectors. This support requires balancing the measured use of force with an emphasis on nonmilitary programs.

Political, social, and economic programs are most commonly and appropriately associated with civilian organizations and expertise. However, effective implementation of these programs is more important than who performs the tasks. Civilian organizations bring expertise that complements that of military forces. At the same time, civilian capabilities cannot be employed effectively without the security that military forces provide.

Effective PRT leaders understand the interdependent relationship of all participants, military and civilian. PRT leaders must orchestrate their efforts to achieve unity of effort and coherent results. If adequate civilian capacity is not available, military forces may be required to fill the gap. Reconstruction programs for political, social, and economic well-being are essential to achieving stability and developing the local capacity that commands popular support. To effectively work together, PRT planners should consider the following:

- Know the roles and capabilities of U.S., IGOs, and host nation partners.
- Include other participants, particularly host nation partners, in planning at every level.
- Support civilian efforts, including those of NGOs and IGOs.
- Conduct, facilitate, or participate in political, social, informational, and economic programs.

Continuity of Operations

Continuity of operations is the degree to which there is continuous conduct of functions, tasks, or duties necessary to accomplish a mission. It includes the functions and duties of the team leader, as well as the supporting functions and duties performed by members of the team.

PRTs can require a significant amount of time to effect change within an area or province. The various agencies involved in providing personnel as team members must ensure that there are not gaps in functional coverage or a wholesale turnover of personnel over long deployments. Either of these actions will result in the PRT losing valuable understanding of the environment and could affect relationships with the local government and the people as a whole. Though not required, it is highly encouraged that leadership positions (team leader and deputy team leader) have their changeovers as far apart as possible to ensure continuity of interface with local leaders.

Flexibility

The components of a PRT are adaptable to any situation, from immediate post conflict with no governance structure (PRTs will not act as a government structure) to an unstable but developed structure requiring assistance. This flexibility is essential for PRTs to be applicable across the full spectrum of potential situations requiring interagency and multidisciplinary coordination and cooperation. Flexibility in the PRT framework facilitates scalability of management and response activities.

Guiding Principles

The primary activities of the PRT are to conceive, plan, coordinate, and/or execute reconstruction and initial development projects and programs. Though PRTs are not development institutions per se, PRTs should adhere to the following development communities' principles to the extent possible:

- **Ownership.** Build on the leadership, participation, and commitment of a country and its people.
- **Capacity building.** Strengthen local institutions, transfer technical skills, and promote appropriate policies.
- **Sustainability.** Design programs to ensure their impact endures.
- **Selectivity.** Allocate resources based on need, local commitment, and foreign policy interests.
- **Assessment.** Conduct careful research, adapt best practices, and design for local conditions.
- **Results.** Focus resources to achieve clearly defined, measurable, and strategically focused objectives.
- **Partnership.** Collaborate closely with governments, communities, donors, NGOs, the private sector, IGOs, and universities.
- **Flexibility.** Adjust to changing conditions, take advantage of opportunities, and maximize efficiency.
- **Accountability.** Design accountability and transparency into systems and build effective checks and balances to guard against corruption.²

Imperatives

In addition to the above guiding principles, the PRT should:

- Focus on improving stability.
- Operate as an integrated military-civilian organization.
- Work to a common purpose or end state with unity of effort.
- Lead from behind, ensuring host nation ownership. Promote host nation primacy and legitimacy. (Remember and respect that the operational pace will be that of the host nation.)
- Actively engage with the governor, host nation central government officials, the local communities and population through provincial councils, provincial development committees, and other established and traditional bodies.
- Facilitate the visibility of the host nation government's presence in the province by assisting official visits to remote districts and villages (e.g., transportation and communications).
- Promise only what you can deliver: manage expectations (under-promise and over-deliver).
- Engage in programs or projects that your PRT rotation can complete or handover. However, avoid focusing on only short-term projects at the expense of long-range strategies.
- Plan sustainability at the outset.
- Ensure that projects do not duplicate the work of others.
- Ensure that interventions at the provincial level support the host nation's national processes and development plan or strategy.
- Lay the foundations for long-term sustainable changes.
- Be committed to consulting and/or working with international partners, such as IGOs and NGOs.
- Be aware of and respect civil-military sensitivities—lives may depend on it.
- Have a finite lifespan, linked to an end state of improved stability.

Endnote

² Andrew S. Natsios, "The Nine Principles of Reconstruction and Development," *Parameters*, Autumn 2005.

Chapter 4

Strategic Guidance and Authorities

Overarching Interagency Strategic Guidance

Senior interagency officials provide strategic guidance through cabinet-level principals' committees (PC) or deputies' committees (DC). The committees are chaired by the National Security Council and reflect the grand strategic goals as laid out by the President. In turn, the PC or DC may create or task existing interagency policy coordinating committees or country reconstruction and stabilization groups to flesh out and further develop implementation based on the strategic guidance.

Though in charge, the Chief of Mission (COM) or designated authority, in concert with the National Command Authority, may designate a specific U.S. government (USG) department as the lead agency. In a situation where active combat is expected or underway, the Department of Defense (DOD) may be the lead with other agencies in a supporting role. Where the environment is clearly post-conflict and instability has diminished, the lead shifts to the Department of State (DOS), which is responsible for coordinating the efforts of other civilian departments and agencies.

In the field, operational guidance normally runs through the relevant combatant command to a joint task force or other appropriate formation on the military side and through the COM (where there is an existing U.S. embassy) or presidential envoy on the civilian side.³ Whichever department has the lead, all efforts at the field level should be made to integrate the directives from both the supported and supporting departments. The geographic combatant command's strategic plan should delineate the agreed stability and political conditions necessary to shift the military from a supported command to a supporting command, wherein the COM will assume lead for USG efforts. Certain circumstances may result in the recognition of joint civilian-military command, preserving unity of effort if not unity of command.⁴

Operational Interagency Guidance: Roles Played by the PRT

Operational interagency guidance is the implementing glue between overarching strategic goals and local execution. This guidance delineates the separate agency areas of responsibility (AORs) and ensures a common assessment/understanding that each line of operation or sector reinforces the others. The guidance should tie national/sector development programs with the stability objectives and activities of the PRT.

Although PRTs mostly focus on the operational and tactical level, the interagency nature of their structure and activities cuts across any number of sectors (security, governance, and economy) and must be aligned with corresponding national and sector efforts. Any discontinuity or gaps in these local efforts is likely to manifest itself as difficulties in achieving unity of effort within the PRT's AOR. Therefore, PRTs play an important role in informing and refining operational guidance from intermediate or higher headquarters and ensuring that the local objectives are effective, attainable, and aligned with operational and strategic goals.

Implementing Agency Guidance

Each agency active within the PRT provides appropriate implementing guidance to its respective agency elements deployed in the PRT. Depending on the actual makeup of the PRT, the relevant agencies are likely to include DOD, DOS, U.S. Agency for International Development (USAID) and others— including the Department of Agriculture and Department of Justice. Drawing on the integrated operational guidance developed at the embassy/joint task force level, each agency provides a framework for its PRT personnel to identify key issues, priorities, timelines, and possible measures of effectiveness.

It is vitally important that the PRT leadership ensure that the guidance coming in from multiple agencies is carefully coordinated and mutually reinforcing, and that they report to higher headquarters when there are inconsistencies or when difficulties occur. The PRT is an important “ground truth” check on interagency coordination at higher levels; if differing guidance cannot be integrated at the PRT level, it may well be indicative of disjointed coordination or planning at the regional or national level. The PRT’s activities are then developed through a common assessment of the situation and integrated implementation plan.

Funding Guidance and Authorities

Funding for activities within the PRT AOR will likely come from several sources, although country- and regional-specific circumstances preclude a definitive list. Examples include: economic support funds (ESF) (DOS/USAID); overseas humanitarian, disaster, and civic aid (DOD); Commander’s Emergency Response Program (CERP) (DOD); and International Narcotics Control and Law Enforcement (INCLE) (DOS).

In many cases, such as ESF and INCLE, the PRT is likely to play an oversight or supporting role. In Iraq and Afghanistan, CERP provides military commanders with funds they can directly program and disburse; however, it is not presently clear to what degree this practice will carry over in future reconstruction and stabilization missions. Legal restrictions on the use of certain funds and the existing sanctions on the country in question require the separate management of these funds by the organization responsible for their expenditure. In addition, constraints, including prohibitions on certain uses of the funds, must be taken into account in planning how and whether the PRT will undertake specific activities.

PRT leadership must be fully aware of the guidelines and authorities that are attached to each funding source and determine the best use of these funds, to include which funds are best used for specific projects. Balancing this multitude of considerations is an essential task of the PRT’s interagency leadership to ensure an effective, efficient, and sustainable work plan.

Endnotes

³ Regional bureaus in the DOS (and their respective assistant secretaries) work directly with the embassies that fall within their responsibility. There is no civilian equivalent to the combatant commanders.

⁴ See Annex C on Iraq. Multi-National Force-Iraq and the ambassador are jointly responsible for achieving mission objectives.

Chapter 5

Implementing Strategy

Planning a Course of Action

Provincial reconstruction teams (PRTs) have used a variety of informal and formal planning processes, as well as short-term and long-term focus throughout their existence. However, a consensus is emerging that PRTs are most effective when they develop a multi-year plan of action based on their mission analysis and shaped by their analysis of what is driving instability and conflict in their area. The PRT plan should be:

- **Driven by its mission guidance and directed tasks.** In addition to the PRT's own plans, the PRT needs to interface with and help implement other plans. There may be multiple documents (host nation, U.S. government [USG], international [e.g., United Nations or North Atlantic Treaty Organization]) that should be acquired and understood. Some U.S. planning documents may be classified, so the PRT may need to work with contacts, usually at the embassy, to learn what strategies are relevant. Although the responsibility for coordinating these various frameworks falls at a higher level than the PRT, to be fully effective, the PRT leadership needs to be cognizant of all relevant strategies and the degree to which the PRT will interface with each strategy. Whether the mission is counterinsurgency (COIN), post-conflict stabilization, or reconstruction, the PRT must ensure that its strategy, plans, and actions support and further those overarching objectives.
- **Shaped by a full understanding of the area assigned to the PRT.** As described below, the plan should be developed following an assessment of the threats to stability in the PRT's area of responsibility (AOR), including factors that increase and decrease the likelihood of conflict. The assessment should strive to determine the key impediments to achieving mission success. There may be instability based on tribal competition, conflict perpetrated by criminal or insurgent activities, or weak local institutions that prevent effective extension of the national government. This assessment provides a common operating picture for all USG actors in the province that will shape, sequence, and focus their efforts towards achieving the mission of the PRT.
- **Multi-year.** PRT team members understand that achieving success in their AOR will take many years even though they are often deployed for no more than a year. Rather than a series of one-year plans, it is important to develop a multi-year (three to five) strategy that promotes continuity of effort. The strategy should include: 1) Key strategic interventions that are necessary to address the causes of instability and conflict; and 2) A long-term end state goal and the required objectives to achieve sustainable stability sufficient to provide an environment where normal development programs can flourish. The strategy can and should be reviewed and routinely revised, particularly before unit rotations or large personnel turnovers or as guidance or conditions change. The strategic objectives provide the basis for a multi-year implementation plan that should cover a time frame of at least two years to facilitate continuity.

- **Interagency.** The PRT is an interagency team and needs to plan as a team. Ideally, the PRT's planning team should include functional, regional, and planning experts representing all the agencies active in the PRT. There may be a tendency for each agency to want to perform separate assessments and then build separate action plans based on those assessments. Institutional culture, personal expertise, rotation cycles, and separate reporting chains can all push PRT members in this direction. But without a joint assessment, strategy, and implementation plan, the PRT will lack a common understanding of the situation, making it hard to agree on where resources should be focused and prioritize and integrate each agency's efforts.

Start with an Integrated Assessment

The PRTs are deployed first and foremost to foster stabilization, and their actions, projects, and programs should all support that goal. To do this, the PRT members need to assess and understand the factors that cause instability and conflict in their area. The local causes of instability and conflict may be similar to those driving the national conflict, but there will likely be additional complexities and local aspects of the problem (e.g., local resource issues and relationships among local actors, tribes, sects, or groups). The PRT's job is to understand what is causing the instability and conflict in their area, so that its interventions can reduce conflict and promote a more stable environment:

- **Drivers of conflict.** While the complexity of a PRT's area of operations cannot always be fully analyzed by a specific doctrine such as COIN or any one methodology, there are several good conflict assessment frameworks that can form the basis for a PRT's expanded assessment process. Conflict is frequently conceptualized and assessed in terms of sources/causes, parties, actors, "drivers," and potential triggers. The sources and root causes of conflict can be described in terms of stakeholders' frustrated needs and grievances. The "drivers" of conflict are the dynamics of how those frustrations and grievances are expressed and manipulated. Triggers are often thought of as shocks to the system (a drought) or events (an election) that spark conflict. The PRT needs to assess the potential drivers of instability and conflict in its AOR. These may include resource competition, sectarian animosity, ethnic violence, lack of meaningful economic opportunity, and culturally sanctioned vendetta. This assessment entails mapping the social, cultural, political, and economic networks that the population lives with daily. The mapping is not a doctoral dissertation, but it should touch on the key aspects of the environment that impact the level of conflict.
- **Assessment tools.** There are several common conflict assessments tools that can be used by the PRT, including the Interagency Methodology for Assessing Instability and Conflict developed to gather situation-specific information for policy-level strategic planning; USAID's Conflict Assessment Framework designed for the strategic and operational level; and USAID's Tactical Conflict Assessment Framework, which was developed to inform tactical level planning and program design.
- **Performing a conflict assessment.** Listening to and engaging with the local population, including different levels of society and the various

groups in the PRT's area, are keys to a good assessment. Typical steps in a conflict assessment include:

- Collecting data (through interviews, observations, field-based activities, or secondary sources). Data should include information on background factors and underlying risks, such as stakeholders' interests/needs; opinion leaders' motivations/means; potential triggers; potential "spoilers"; and international or regional actors or factors.
- Describing the dynamics (conflict drivers) that are factors that contribute to escalation of the conflict.
- Prioritizing the "drivers" according to the degree they contribute to escalation of the conflict.
- Identifying conflict mitigation and resolution mechanisms.

Mitigate Conflict and Build Local Capacity

In the follow-on planning phase, PRT planners decide how to mitigate the dynamics that "drive" the conflict and strengthen the dynamics that mitigate or defuse the conflict. Factors that demonstrate local and regional capacity usually contribute to mitigation of the conflict. These factors include the legitimacy and effectiveness of the host government; its political, social, economic, and security institutions; and the resilience of civil society.

In most interventions in countries in crisis, the USG goal is to achieve a sustainable peace where the host government is able to meet the fundamental needs of its citizens for security, social well-being, just governance, and economic livelihood. In many reconstruction and stabilization environments, this institutional capacity is limited or absent. Identifying the areas of need, mentoring key individuals, facilitating training, and focusing intervention are all potential tools.

Building governmental capacity above the provincial level is clearly beyond the scope of the PRT and is the responsibility of the national-level program; however, the PRT is best positioned to understand the specific needs within the province, district, or regional area within its responsibility and use the information to design local programs and inform national-level planning. While every situation is different, local governments often need help developing processes for citizen input, prioritizing government programs and projects, implementing budgeting processes, and establishing public security capabilities. Keep in mind that not all institutions are governmental; building the capacity of traditional governing mechanisms and civil society (religious groups, business institutions, and political parties) may also be required.

The graph below provides a visual summary of planning process goals (to increase the capacity of local institutions to respond to local needs and wants, while reducing the drivers of conflict).

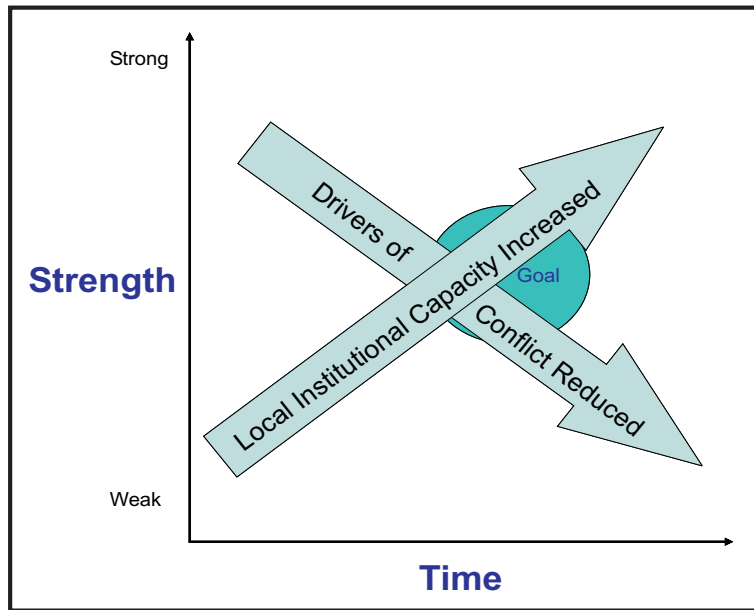

Figure 5-1

Develop Long-Term Strategic Objectives

Once the PRT has assessed local needs, identified key drivers of conflict, and built connections to local institutions, it needs to develop intervention strategies to be implemented through an action plan. For example, if the two major tribes in a PRT's area are engaged in ongoing, low-level hostilities over historic grievances and competition for scarce water resources, the PRT may decide it needs a strategy for a peace-building process supported by a water management strategy to address this underlying source of conflict. Taken together, the major mission elements or objectives should be:

- Developed from an assessment of the causes of conflict and instability.
- Necessary to achieve the goal and succeed.
- Sufficient to achieve the overarching objectives or goal.
- Stated as measurable, realistically ambitious objectives.
- Integrated across agency stovepipes when necessary to achieve the goal.
- Able to help identify cross-sector issues that may be overlooked by the bureaucracy.

The PRT may not have the resources and tools to address larger and more complex issues. In these cases the PRT should flag these parts of the plan for consideration by the embassy and higher military headquarters. For example, the PRT may identify a corrupt and poorly trained police force as a significant factor undermining local support for the national government. Police training likely needs to be conducted as part of a national program and should be raised with the

embassy. However, setting up a public safety commission to represent citizen interests in interactions with police authorities might be something the PRT could help with at the local level.

Develop an Implementation Plan with Tasks, Activities, or Interventions

The implementation plan consists of the major mission elements or operational objectives the PRT has identified and the intervention activities or essential tasks the PRT should undertake to achieve them. In the example involving competition over water resources, the PRT may want to seek input from a hydrologist. The hydrologist might recommend a regional solution, which might be expensive and need to be referred for higher level action. But he might also identify smaller local projects that would improve lives in the short term and provide space for the peace-building process to proceed. The completion of these projects might be identified by the PRT as essential tasks. Essential tasks should be:

- Necessary and, taken together, sufficient to achieve the major mission element (MME)/objective.
- Stated as measurable outcomes.
- Managed by implementing agencies or PRT members.

PRTs can draw on a document called the Post-Conflict Reconstruction Essential Task Matrix to help possible tasks and programs. The document can be found at: <http://www.state.gov/documents/organization/53464.pdf>.

The action plan should identify which agency or PRT member has the lead for a specific program or action and the source of funding. However, not all the essential tasks involve expending program funds; some may involve diplomatic, political, or other initiatives undertaken by the PRT's leadership and advisors. The plan's time frame varies according to the circumstances, the nature of U.S. involvement, and the overall strategic plan but should be at least two years long to provide continuity of PRT personnel. While actions and programs for the current year will need to be identified, the MME/objectives will likely be multi-year.

The PRT constantly needs to balance conflicting goals. Is effective direct intervention in local disputes more important than efforts to increase the capacity of local security forces? Should limited reconstruction funds be used to build necessary government infrastructure or to increase the general population's general welfare. (Are police stations more important than sewage systems?)

There will always be tradeoffs in the planning process, including staffing and budgetary cycles, limits on uses of funds, national versus provincial imperatives, different time frames for achieving immediate security requirements versus stability, and other constraints that will affect what can be done. But a good planning process and framework leads to the best use of resources within the inevitable constraints.

Given the changing nature and stability dynamics of the AOR, the implementation plan should also identify triggers for contingency plan activation to support local and national government response. For instance, natural disasters significantly strain nascent government capacity. The ability of the local government to respond to natural disaster can reduce resulting instability and impact the population's

perception of government legitimacy. A PRT contingency plan to support government response can help the government address short-term stability requirements while also addressing long-term capacity building.

Measuring Performance (Metrics)

PRTs will be asked to assess their progress and report on it. This assessment will probably include the development of indicators or metrics as part of a process called performance monitoring. Performance monitoring involves the repeated review of reported information to inform decision making. The reported information is a combination of metrics, other information gathered, and the review and analysis of that information. The purposes of performance monitoring are to gather and present systematic, analytic information for the PRT's own use in assessing the impact and effects of its efforts; to inform decision makers up the chain of command; and to report to Congress and the public. The best time to consider how the success of the PRT's plan will be measured is while the plan is being developed. Note that there will also be demands from higher agency levels for assessments that may or may not track those of the PRTs.

Impact assessment can be difficult in a reconstruction and stabilization context—the full impact of a PRT's activities may not become clear for some time, and public databases that might track changes in indicators over time may not exist or be reliable. Nonetheless, it is important that the PRT assess its output—the immediate effect of its activities—and the short- and long-term impact of these activities. Ultimately, the impact is what matters. Output is usually easiest to measure, (e.g., number of wells drilled, schools built, police trained), but it does not measure the effects the PRT is trying to achieve. Outcomes or intermediate effects (how many have access to clean water, growth in school enrollment, public perception of police) and longer-term impacts of activities on the overall situation (impact of wells on local power structure, perception of education's impact on social values or economic prospects, impact of police training on public security, and support for the government) may require more creativity. A few clear, insightful measures are better than many indirect or less obvious ones. Examples of indicators include:

- **Impact indicator.** Overarching goals are achieved:
 - Functioning economy that provides tax revenue and facilitates licit economic activity:
 - * Percent of country's economy that can be taxed by federal government
 - * Relative personal income rates across key identity groups
 - Government that ensures the rule of law and protects civilians:
 - * Polling on “how safe citizens feel” across identity groups
 - * Human rights assessments
 - Political processes that are seen as legitimate and credible:

- * Participation in political processes by major groups or factions
- * Civil/political rights assessments
- **Outcome indicator.** Measures the effect of activities on achieving broader objectives:
 - Increase in employment
 - Shorter pre-trial detention periods
 - Increase in participation in political processes by former combatants

While output indicators can help PRTs track their efforts, when USG planners and policymakers use the terms “performance” or “results,” they are referring to those objectives nearer the top—at least at the outcome level.

Continuity Process

PRT staff is subject to a high rate of turnover. Civilians generally serve 12 months but often have gaps between assignments, while core military members serve 12 months and often have assignment overlaps. However, some military members may only serve six months. Unfortunately, changes in personnel often result in changes in PRT direction, objectives, and programs. Without a long-term plan, new arrivals are left to improvise their own programs, drawing on their own expertise, which results in choppy and ineffective PRT programming that wastes time and resources.

A long-term common operating picture and strategic implementation plan assists with continuity. During their predeployment training, PRT members should strive to understand the specific area analysis and implementation plan provided by their predecessors. The new PRT should be aware of the causes of instability and conflict; strategies and implementation interventions, programs, activities, and measures of effectiveness as they relate to their work; the objectives of the maneuver brigade and other PRTs in the particular region; and the longer term USG provincial goals and objectives. In addition to forwarding the planning documents, during the last month of deployment, PRT and military teams should complete the following tasks:

- Capture their experiences (both lessons learned and good practices) and present them to the incoming PRT, maneuver commanders and staffs, and implementing partners.
- Send materials from briefings to PRT training units, both military and civilian, in the U.S. to update training materials.
- Attend and assist with the training incoming teams and overlap with their successors, if possible.
- Highlight particularly valuable lessons learned on how to work in the environment; how to be a team player with civilian/military teams; how to engage the local community appropriately; and how to alter

programming based on local input, while making it complementary to PRT and the maneuver commander's goals.

Chapter 6

Management and Structure

Strategic to Provincial Reconstruction Team (PRT)

Management of a PRT begins at the strategic level in Washington, D.C., and works its way through the chief of mission (COM) and joint task force (JTF) to the PRT. Chapter 4 explains the strategic guidance and Figure 6-1 shows how the interagency bodies coordinate this guidance and how it flows to the PRT.

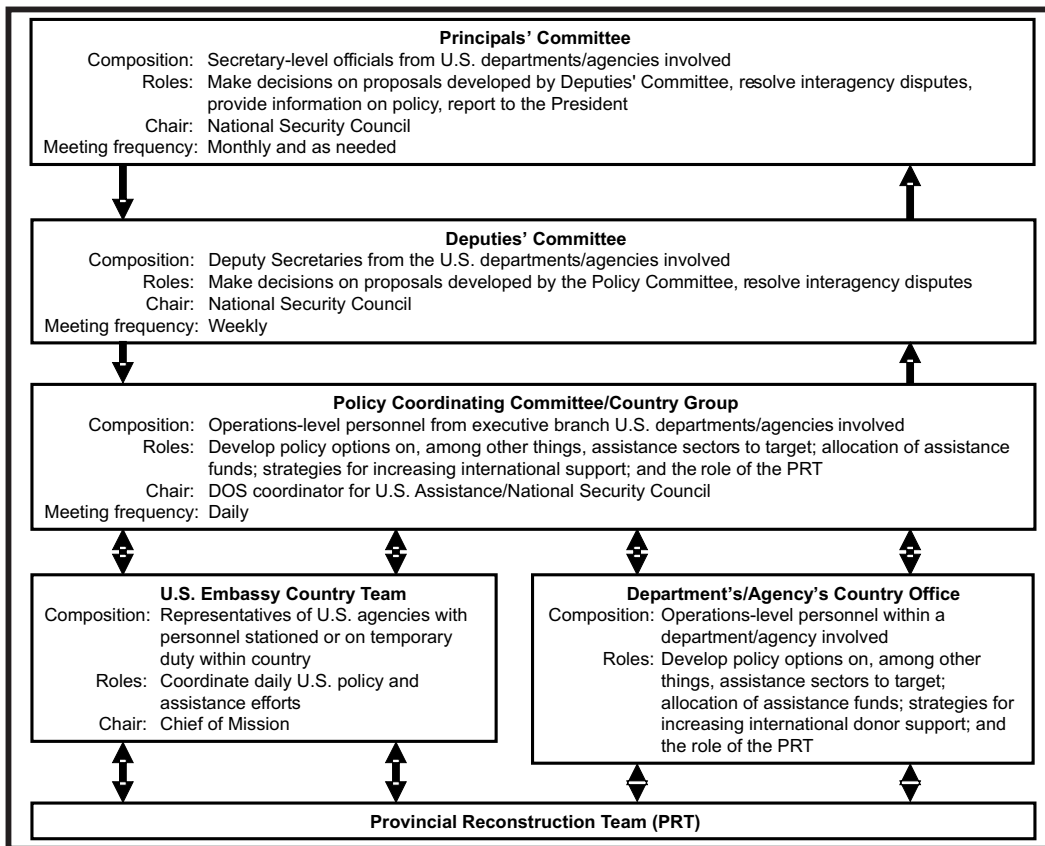

Figure 6-1: Interagency coordination mechanism ⁵

Operational guidance comes from the separate departments to the PRT. (See Figure 6-2.)

Participating agencies maintain primary control of the capacity and programs they allocate to PRTs because of fiduciary responsibilities. The COM may elect to establish an executive steering committee to coordinate each of the agency's reconstruction efforts within the country. This committee serves as the mechanism to ensure coordinated PRT guidance from each participating agency. The PRT has two lines of authority running to it; however, the brigade/regimental combat team has only force protection and sustainment authority over the PRT and has a large input, at the direction of the JTF commander, within the security sector. The authority for all other sectors of the PRT operations is the COM. Above all, it must

be understood that the COM is the executive agent responsible for all reconstruction efforts within the country where he is the principal U.S. Government (USG) representative.

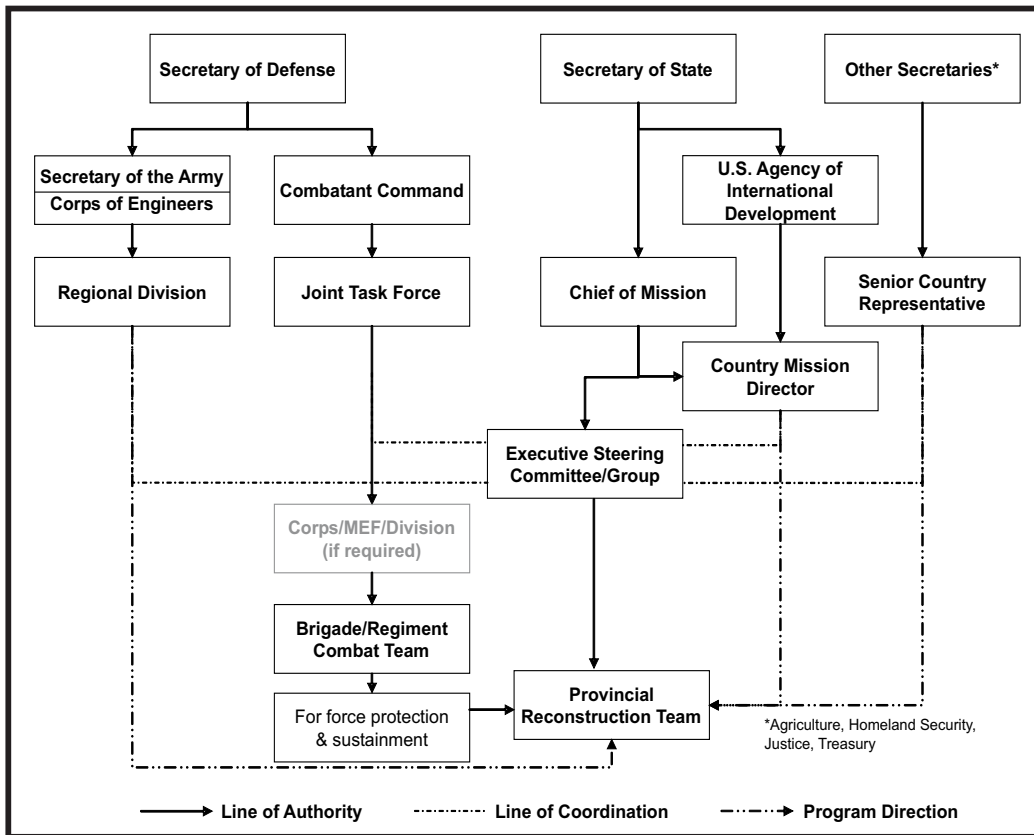

Figure 6-2: Lines of management

PRT Management: The Integrated Command Group

The level of integration of the participating agencies or nations at a PRT varies from mere collocation to unity of command. In general, at a minimum, each PRT should seek to achieve unity of effort. Unity of effort can be advanced through the creation of an integrated command group or executive team. This group is composed of the senior member of each agency or nation participating in the PRT. Ideally, the command group should be collocated (within the PRT) and have a highly consensual and considered approach to decision making.

There should be regularly scheduled meetings involving all members of the command group. The command group is responsible for taking top-level direction and, in combination with U.S. and host country national priorities, determining the PRT strategy to include approach, objectives, planned activities, and monitoring and evaluation systems. It is the command group that must write an implementation plan for the PRT consisting of an end state, objectives, and coordination between lines of operation. Without an integrated command group, a PRT will be unable to harmonize the diplomatic, economic, and military lines of operation and will fail to act with unity of effort. In order to succeed, PRTs must become truly integrated

civil-military structures and not just military organizations with “embedded” civilian advisors or bifurcated organizations with two separate components (military and civilian) that operate separately from one another. A PRT is a civilian-military partnership.

Roles and Responsibilities

Team leader

A myriad of agencies have personnel and resources assigned to a PRT. However, the COM must assign a single individual to provide assistance when required and answer questions that may arise from the President or the host nation government. Quite often the senior diplomatic officer fills this position; however, the environment of the province may dictate that an individual from another agency (Department of Defense or Department of Justice) takes the lead of a PRT.

Diplomatic officers

Though a preponderance of resources available to a PRT is often provided by an agency other than the designated senior diplomatic officer, the diplomatic officer is considered the first among interagency and international equals. The senior diplomatic officer is responsible for providing policy and political guidance to the PRT based on diplomatic goals outlined by the COM and his assessment of the local political landscape (by definition, the political landscape subsumes the military and development perspectives). This link to the COM ensures absolute clarity of purpose for all USG agencies, as well as the ability to reach-back to the COM to communicate local priorities that may require assessments by national powers. The diplomatic officer is also responsible for keeping the COM informed on the issues and dynamics of the PRT’s area of responsibility (AOR).

Military officers

The military component of the PRT has a comparative advantage in specific functional tasks such as planning; coordination; project management; and technical expertise such as warfare, training, and engineering. However, the primary value-added capability of the PRT’s military component is the organizational and logistics resource capability, as well as the force projection it gives to the PRT to penetrate insecure areas.

Development officers

The development officer has a comparative advantage in understanding the social and economic aspects of instability and insecurity. Likewise, the development officer has a comparative advantage in the planning, design, and implementation of reconstruction and developmental activities in support of politically derived objectives (regardless of funding source).

Host government representatives

Some PRTs may have host government representatives. The existence of the PRTs is predicated to a large extent on the premise that local government lacks capacity at the institutional and individual level. For this reason, it is not likely that the host government representative has the capacity to do more than assist the PRT in better understanding the environment, including friendly and enemy forces and provide advice on how to engage and build local structures and capacity.

Local support staff

Each PRT has some mix of local support staff with the responsibility of assisting in running the PRT from labor to translation to representation.

The roles and responsibilities of other civilian U.S. and international civilians (such as contractors) are dependant on the mission of their agency or program and the authorities negotiated with the PRT program or agencies involved.

PRT Structure

The structure of a PRT is a composite of military and civilian elements. Decisions on the size and nature of each PRT are determined based on the factors within the province such as: the security situation, the status of reconstruction, development, effectiveness of governance institutions, and the presence of other intergovernmental and nongovernmental organizations. PRT organizational structure should be based on unity of effort, clear coordination, and good communications.

PRT Functional Areas

Administration

An administrative staff aids the team leader and other supervisors in getting things done through its knowledge of and skills in dealing with organization, methods, funds, people, equipment, and other tools or resources of management. Duties typically include the following:

- Helping leadership identify financial, personnel, and material needs and problems.
- Developing budget estimates and justifications; making sure that funds are used in accordance with the operating budget.
- Counseling management in developing and maintaining sound organization structures; improving management methods and procedures; and seeing to the effective use of men, money, and materials.
- Collaborating with personnel specialists in finding solutions to problems arising out of changes in work that have an impact on the mission and team members.

Due to size limitations, most PRTs do not have an administrative staff that has expertise in all the above duties. However, the individuals assigned to these

positions should be knowledgeable enough to work with the central servicing offices that handle these issues.

Operations and planning

The operations and planning staff ensures that directions and plans from the national level are articulated to actionable processes within the PRT's AOR. This staff acts on the behalf of the team leader in strategizing, coordinating, and communicating stabilization and reconstruction actions and is responsible for planning both the short-term and long-term reconstruction activities within the PRT's AOR.

A major function of this staff is establishing, coordinating, facilitating, and maintaining contact and communication with the national reconstruction office, other PRTs, local governments, national and international agencies within the AOR, and the supporting military organizations. Through these efforts, the team leader ensures the appropriate influence of U.S. stabilization and reconstruction efforts on the local populace.

This staff ensures all activities within the team are synchronized across functions, as well as with those organizations operating in tandem with the PRT within their AOR. In addition, this function is responsible for ensuring the efforts of the team are in congruence with national-level efforts. Other responsibilities include: 1) Directing the PRT's long-range planning process and coordinating it with the national planning process; 2) Consulting with and assisting PRT components in planning; 3) Coordinating the PRT's annual and short-term planning processes and supporting other PRT elements in project, activity or task planning, preparation, coordination, and execution; and 4) Conducting analysis of resource requests submitted by PRT components to develop resource recommendations for the team leader, to support the planning process, and to fulfill national requirements.

Support

The support component is the PRT's mission enabler and provides the essential capabilities, functions, activities, and tasks necessary to sustain all elements of the PRT. Support includes, but is not limited to, supply, maintenance, transportation, health services, and other services required to accomplish the PRT's missions within its AOR.

Logistics

The logistics section is responsible for procuring, maintaining, and transporting material and personnel to ensure the PRT accomplishes its mission. Duties typically include the following:

- **Supply.** Acquires, manages, receives, stores, and issues all classes of supply required to equip and sustain the PRT. This duty also includes determining requirements for the PRT and forwarding the request up through channels to the appropriate issuing authority.
- **Transportation.** Provides for the movement of personnel, equipment, and supplies to support the concept of operations. Transportation sections must be aware of additional military, commercial, and multinational

capabilities (to include motor, rail, air, and water modes) available to the PRT and understand the process of requesting those transportation assets.

- **Maintenance.** Takes the necessary actions to keep materiel in a serviceable, operational condition, returning it to service, and updating and upgrading its capability. When conditions and qualifications permit, this duty includes performing preventive maintenance checks and services; recovering and evacuating disabled equipment; diagnosing equipment faults; substituting parts, components, and assemblies; exchanging serviceable materiel for unserviceable materiel; and repairing equipment. The ultimate key to effective maintenance is anticipating requirements.
- **Contracting.** Advises the team leader and, on behalf of the team leader, controls and manages the contracting support required for the PRT. This duty includes requirements, determination, and funding and support to contractors.

Communications

This section is responsible for meeting the PRT's communications needs and accomplishes this task by ensuring the elements of the PRT communications infrastructure, including mobile assets, meet the mission requirements. This section manages the PRT communications assets and establishes support agreements with the supporting military unit or the host nation.

Information technology

The information technology section is responsible for meeting the PRT's information technology needs and accomplishes this by ensuring the elements of the PRT information systems infrastructure meet the mission requirements. This section manages the PRT information technology assets and establishes support agreements with the supporting military unit or the host nation and may be a sub-element of the communications section.

Health services

The purpose of the health services section is to promote, improve, conserve, or restore the mental and physical well-being of the personnel assigned to the PRT. The typical level of care includes immediate lifesaving measures, prevention of disease and injury, operational stress control preventive measures, patient collection, and medical evacuation to supported medical treatment elements. This function is normally accomplished by military or contract personnel.

Force protection

This section provides the necessary security function required to protect the PRT at its operations base and while it is performing its assigned mission. Each PRT is responsible for providing a level of security appropriate to the local security situation. In broad terms, three elements are required: compound security, drivers and escorts, and a small tactical reserve or quick reaction force. Best practice suggests that the compound security force should be a combination of military

personnel or contractors and local nationals. Employment of the latter, if sourced from the immediate local population, contributes to the overall level of force protection, enables military personnel to be released for more demanding tasks, benefits the local economy, and acts as another method by which the PRT can engage positively with the local population. However, PRTs need to carefully consider the sources of such manpower.

Facilities support

Facilities support provides the essential services to enhance the PRT's quality of life during operations. Their services consist of clothing exchange, laundry and shower support, mortuary affairs, food services, billeting, and sanitation. This support is normally contracted out but may be provided by a supporting unit or the host nation.

Endnote

⁵ "Afghanistan Reconstruction: Despite Some Progress, Deteriorating Security and Other Obstacles Continue to Threaten Achievement of U.S. Goals," *Report 05-742*, Government Accounting Office, July 2005.

Annex A

Support References

Section I: Stability⁶

Stability in the simple sense of the word means “firmly established.”⁷ The provincial reconstruction team (PRT) mission is narrowly focused to help firmly establish government and governance in a conflict or post-conflict environment. In other words, PRTs exist to help the host nation’s government gain a monopoly over the legitimate use of force and extend its authority and reach throughout the country.

One of the principal roles of the state is to monopolize the use of legitimate force, because if a monopoly does not exist, the structure of law and order breaks down into smaller units resulting in anarchy or decades of fighting between various factions in society including tribes; ethnic, ideological or political identity groups; warlords; and criminal elements. The state must have a monopoly over the legitimate use of force and other basic state functions: armed forces, policing, judiciary, taxation, public infrastructure, and social services.

Helping the host nation’s government gain control over the use of force is only half of the PRT mission. The other half involves increasing the legitimacy and effectiveness of the government within its constituency. While a government may have *de jure* legitimacy through international recognition or by winning an election, *de facto* legitimacy is a much more important indicator of stability. “De facto” legitimacy implies a social contract between government and the people, where the former undertakes to provide services (welfare, security, protection of human rights, equitable opportunities, and access to resources) for the common good in return for the people’s support, including recognition that the state has the monopoly on the legitimate use of force.

When a government fails to live up to its part of the social contract, people may withdraw their consent to be governed and turn to alternate sources of power. While this may, under certain circumstances, be completely understandable—for example, in a dictatorship—it will inevitably cause a degree of instability. This instability can then be used to promote the interests of other groups whose agendas are motivated more by political, economic, or ideological gain rather than by the welfare of the people.

The root causes of violent conflict can often be traced to a combination of poverty, political exclusion, and the inequitable distribution of resources, which all add up to human insecurity. It is through tackling these structural roots that violent conflicts can be mitigated and future outbreaks prevented.

Looking at instability created by violent conflict in structural terms allows a more nuanced understanding of what stability is. Preventing the outbreak of violent conflict requires not just an operational engagement with disarmament, demobilization, peace keeping, aid, and political conditionality, it also requires immediate work on poverty, exclusion, and inequity. Without attention to physical, economic, and political security, the root causes of violent conflict remain unaddressed, and the risk of escalation will remain.

Although stability may involve aspects of development, it is not development. Stability is carefully designed to enable the environment for development to take place by working on security and conflict. Working on socioeconomic development alone, without attending to physical insecurity, exclusion, and inequity will limit the opportunities to bring about long-term development. Thus, stabilization is a necessary precursor to sustainable development.

The Stability Matrix

Because the goal of the PRT is to achieve stability, the team must create an environment where an authority is both legitimate and effective in the use of force. The PRT works with all available stakeholders and resources to bring stability to a population by enabling the legitimacy and effectiveness of governance and government institutions.

The stability matrix strategic framework (see Figure A-1) presented below represents one framework currently available to PRTs to guide their activities and efforts. The stability matrix framework has the benefits of linking mission, strategy, targeting, activity, design, and implementation; measuring impact; and evaluating success. The stability matrix graphically illustrates stability by plotting its two primary components of legitimacy and effectiveness on perpendicular axes. The resulting four quadrants are then classified broadly as exhibiting the characteristics of low stability, medium stability, or high stability.

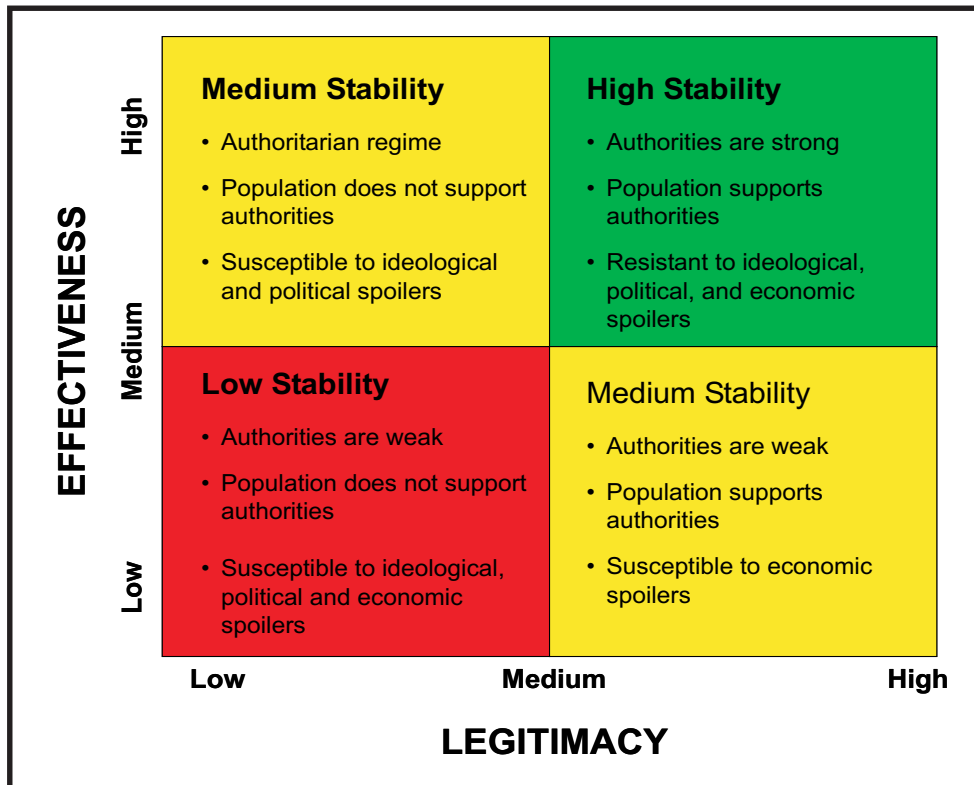

Figure A-1: Stability matrix

Explanation of quadrants

The most stable state (upper right quadrant) is the result of the effectiveness and legitimacy of the governing authority. The authority has effective security forces, and the population supports the authority against competing political entities. This state is one that is resistant to criminal activity because the state can eject these spoilers. This state is also resistant to political and ideological agitators because the population will not offer such spoilers safe haven but will identify them to the authorities. This state represents enduring stability and is the appropriate mission of the interagency strategy represented by the PRT.

The lower right quadrant represents a population that supports ineffective government authorities. Therefore, ideological or politically motivated spoilers find little purchase among the people; however, criminal and other violent activity frequently occur due to the lack of government control. Clearly, what must be done in these areas is to grow the effectiveness of the government.

The upper left quadrant represents an authoritarian model of stability. The government is able to deliver services and monopolize the use of force, but it does not have the consent of the people to govern. Criminal activity tends to be low in this area, but political or ideological spoilers have significant influence and must be engaged to bring about stability.

The most worrisome state is the one described in the lower left quadrant. This is a state where the government is ineffective and unsupported by the population, and criminal elements can run rampant. Ideological and political spoilers may be able to gain support from the population to wage an insurgency against the government. In such communities the difficult task of growing both the legitimacy and effectiveness of the government must be accomplished.

Four Lines of Operation

The matrix is designed to inform the PRT's leadership about what effects (i.e., legitimacy or effectiveness) need to be achieved in the area of responsibility. These effects, in turn, will determine the capabilities required to achieve success. The matrix prescribes four lines of operations that hold true regardless of the community being engaged or the effects desired:

- Increase effectiveness of legitimate authorities
- Decrease effectiveness of illegitimate entities
- Increase legitimacy of legitimate authorities
- Decrease legitimacy of illegitimate entities

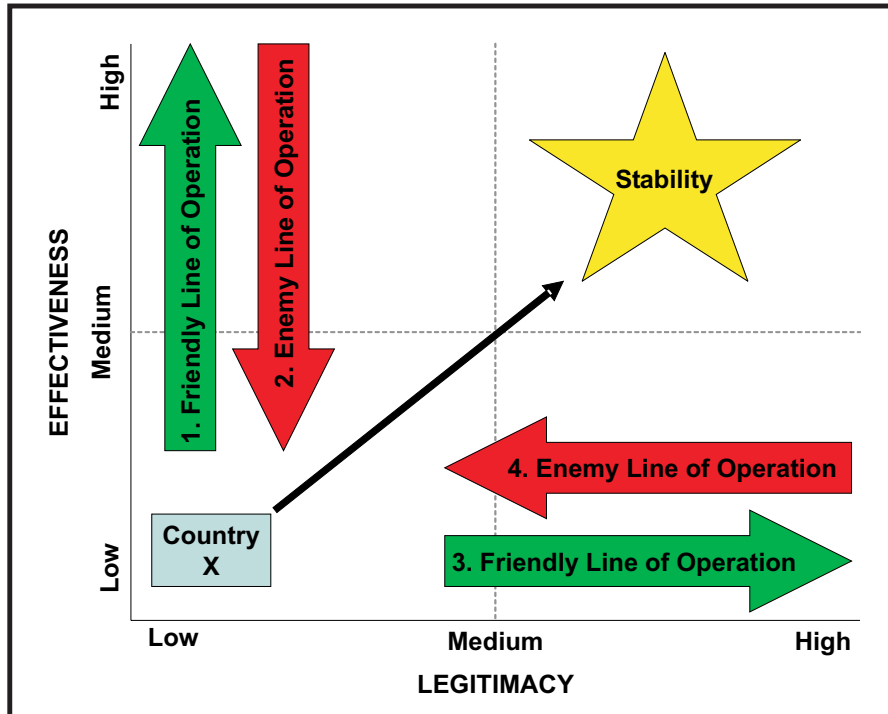

Figure A-2: Stability matrix lines of operation

In military parlance, increasing the effectiveness and legitimacy of state authorities (i.e., lines of operation 1 and 3) can be considered the friendly line of operations. Similarly, countering the effectiveness and legitimacy of non-state (or counter-state) authorities (i.e., lines of operation 2 and 4) represents intercepting the enemy’s lines of operations.

The enemy can be placed in three general categories based on their motivation: economic, political, and ideological. To better understand them and derive a useful definition of the enemy’s center of gravity (CoG) and critical vulnerability (CV), the paragraphs below discuss each group’s motivations. For the sake of this discussion, the CoG for each group is defined as “the sources of strength, power, and resistance,” while CV is defined as “that which is vulnerable and will achieve results disproportionate to the effort applied.”

Economic spoilers⁸ are individuals and organizations that benefit economically from the lack of government control. For example, insurgents and other troublemakers are fighting to repel government rule that would result in a removal of their access to lucrative natural resources. Economically motivated spoilers generally acquire access to a resource and then exploit these resources to fund a patronage network. This patronage network is the economic spoiler’s CoG.

Occasionally this patronage network may benefit a single sub-national identity group. This situation presents a problem. If friendly forces attack such a group, their actions might be interpreted as declaring war against the group because of their identity. This action may then motivate the group to defend itself much more vigorously than they would have if they were only motivated by economic gain. Therefore, when seeking to decrease the effectiveness and legitimacy of such a group, friendly forces should target the group’s access to economic resources as the

enemy's critical vulnerability. To avoid being perceived as attacking the sub-national identity group that might coincidentally be associated with the spoilers, friendly forces should avoid attacking coherent population groups.

Political spoilers are often led by a cadre that is motivated by the quest for political power. For example, an insurgent may state that he wants to rule. He seeks economic support by exploiting resources and accepting funding from outside the country to create a patronage network. He further fuels this patronage network by granting leadership roles in his organization and promising future leadership roles once he takes power. The insurgent and his organization seek to destabilize the region in the hope of creating an opportunity for them to take political power. The CoG of the political spoiler is the leadership, and the promise of authority in a future state binds his organization together. Such organizations are vulnerable to promises of power in the current state, as well as the elimination of the charismatic leader.

The final and most dangerous enemy is one motivated by ideology. For example, the Taliban in Afghanistan are motivated by the ideology of a conservative Islamic theocracy. Its support derives not from the promise of political power or economic gain, but rather from a common "hatred of apostasy" (i.e., its CoG).⁹ The core supporters of this organization seek to defend their identity as strict Muslims against the perception of a threat to this identity by the outside world. Fortunately for friendly forces, the Taliban are not like Maoists of Nepal articulating a promised utopian future. The people of Afghanistan have already seen the dismal state the Taliban wish to restore, and this vision of a counter state is not appealing to most people.

Far too often the enemy is defined by the military as hostile individuals who must all be hunted down and killed or captured. This enemy is often considered to be monolithic as intimated by the common use of the term opposing military forces. These terms are doubly troublesome as they focus efforts on the enemy of the coalition and not the enemy of the process, the people, or the government.

Mao Tse-tung stated that "the guerrilla must move amongst the people as a fish swims in the sea." Therefore, one goal of a counterinsurgency effort is to separate the fish from the sea—to alienate the spoilers from the population. This is perfectly aligned with the stability matrix concepts of legitimizing the government at the expense of the spoilers. According to both doctrines, the higher goal of military and civil action is to win over the population, while killing the insurgents is a supporting or shaping effort. In other words, hostile individuals do not create hostile populations, rather, hostile populations will continue to create hostile leaders until the source of the hostility is alleviated.

If a decision maker fails to understand the nuances of the enemy's motivations, organization, goals, strategy, and means, the actions taken are at best ineffective, and at worst, counterproductive.

Increase Effectiveness and Legitimacy of Constituted Government

Increasing the effectiveness of legitimate authorities in a nation really comes down to the most basic and core function of government as stated above—monopolizing the use of force. For this reason, this line of operation should focus on enabling the state institutions that use force, such as the national army, police, and border police. Most of these programs have large national sponsors supporting institutional reform

and mass training. The PRT should survey these many activities and evaluate their ability to translate into effective government security sector actors on the ground. The PRT should then seek to develop programs and interventions that complement these larger national programs.

In the modern era of nation states, the old sources of *de jure* and *de facto* legitimacy, such as divine right of rule, are no longer relevant. Holding elections, no matter how free or how many people participate, does not necessarily make a government legitimate. Legitimacy is gained and maintained when a government, at a minimum, represents the consensus of the people; operates under the tenets of rule of law; offers acceptable means for competition among various interest groups and potential leaders; provides inclusion for sub-national identity groups and civil society groups; and provides good governance, such as providing transparency of processes.

In the rural, unstable areas of a nation, the representatives of the central government are nearly nonexistent, and the people of these areas have a low opinion of the legitimacy of the government. It is in these areas that sub-national identity is particularly strong. Some have argued that the government could easily co-opt the traditional authority structures to enhance its own legitimacy. The road map for such integration already exists. For example, mechanisms exist by which the traditional local justice system, like the *shura* system in Afghanistan, is integrated into district and provincial justice systems. Furthermore, many states in the Western world have some degree of federalism, decentralization, or delegation of authority. In such states, the use of provincial or district governance institutions (be they traditionally based or based on the Western model) do not subtract from the legitimacy of the central state.

Conclusion

PRTs exist to help the host nation's government gain a monopoly over the use of force through an increase of legitimacy and effectiveness. The PRT must utilize each component of national power—diplomatic, economic, and military—to achieve this goal with an understanding that the human terrain dictates which element has the lead in any given intervention. Every activity the PRT undertakes must be in support of stability. The PRT mission is complete when sustainable stability is achieved. At that time, the PRT can then be dismantled.

Section II: Reconstruction¹⁰

Reconstruction promotes reconciliation, strengthens and rebuilds civil infrastructures and institutions, builds confidence, and supports economic revitalization to prevent a return to conflict. Some instability will exist concurrently with the reconstruction. The major responsibility for reconstruction resides ultimately with the host nation, assisted by international civilian agencies and organizations, but the combat force has a supporting and essential role. Because the combat force and civilian efforts are inextricably linked, harmony and synchronization are imperative. Reconstruction usually begins during combat operations and continues after they are concluded.

Reconstruction consists of actions that support political, economic, social, and security aspects of society. Although the major responsibility for reconstruction is with civilian agencies and organizations, early in combat operations, when critical

and immediate tasks normally carried out by civilian organizations temporarily exceed their capabilities, the combat force may perform those tasks or cooperate to ensure that these tasks are accomplished. In these situations, the combat force provides immediate relief and helps to create a sustainable infrastructure. This “temporary” assumption of military responsibility for civilian tasks could range from a matter of weeks to years in an environment of ongoing security concerns.

Reconstruction consists of the five mission sectors shown in Figure A-3 and discussed below. It is imperative that the appropriate national and intergovernmental agencies conduct a thorough mission analysis for each of these sectors and understand the impact of each sector on the others.

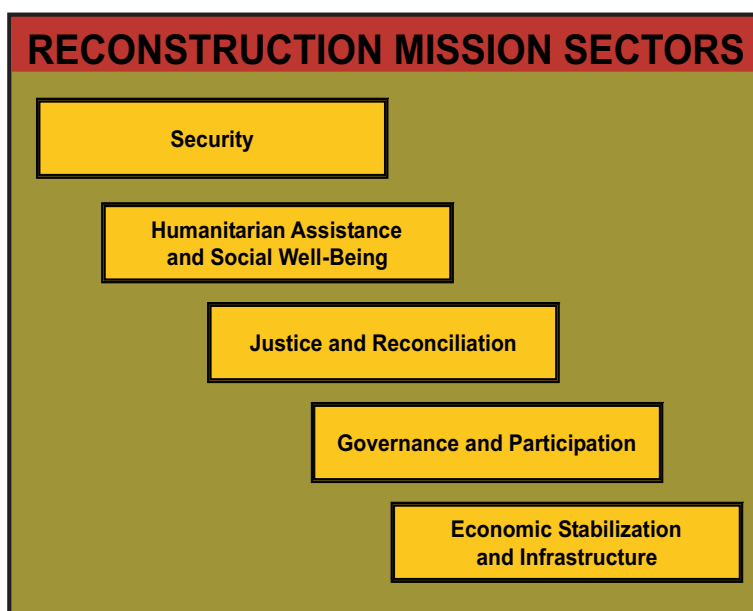

Figure A-3

Fundamentals of Reconstruction

Civil-military harmonization is paramount during reconstruction. Civil-military harmonization includes those civil-military operations (CMO) that promote the coordination, integration, and synchronization of civil and military efforts and actions to build the peace. These efforts and actions must occur across the various institutions and agencies at the strategic, operational, and tactical levels. The following are key considerations for those involved in reconstruction:

- Political leadership establishes and communicates a framework so that coordination of combat force actions are in harmony with supporting multinational, interagency, intergovernmental, and nongovernmental participants.
- Military and civilian agencies develop complementary plans.
- Military and civilian agencies establish coordination mechanisms to support harmonization. A civil-military operations center is one example;

a North Atlantic Treaty Organization civil-military cooperation center is another.

The combat force focuses on supporting civilian agencies, organizations, and the host nation to assume full authority for implementing the civil portion of the peace process, while being prepared to conduct such tasks themselves in the absence of civilian agencies.

Many partners from the international community, such as intergovernmental organizations (IGOs) and nongovernmental organizations (NGOs), though not official implementers of national policy, may contribute to achieving the reconstruction objectives. The role of indigenous leaders and organizations must be considered. Appropriately harmonizing local institutions with international and military efforts is a challenging and essential task.

The ultimate measures of success in reconstruction are social, economic, and political—not military. Therefore, the combat force commander continually seeks a clear understanding of the political objectives and strives to support their attainment.

Reconstruction Mission Sectors

Security

This sector consists of actions taken to ensure a safe and secure environment, develop legitimate and stable security institutions, and consolidate indigenous capacity. These actions should be complementary and concurrent with other agencies' actions that include providing public order and safety; protecting individuals, infrastructure, and institutions; coordinating compliance through host nation mechanisms, such as civil military commissions; and cooperating with supportive public information programs. The goal of the combat force is to create the conditions for other political, economic, and humanitarian reconstruction activities to achieve the political objectives stated in the mandate and to transition from military to local civil control.

Humanitarian assistance and social well-being

This sector includes programs conducted to relieve or reduce the results of natural or manmade disasters or other endemic conditions such as human suffering, disease, or privation that might represent a serious threat to life or that can result in great damage to or loss of property. The goal of this mission sector is to provide for emergency humanitarian needs and establish a foundation for long-term development. The assistance provided is designed to supplement or complement the efforts of the host nation civil authorities and various IGOs and NGOs that may have the primary responsibility for providing humanitarian assistance. The need to establish a secure environment, ensure the survival of the population, and maintain a minimum level of economic activity in a region may require that military units participate in public service tasks during the emergency phase of the operation until such time as the NGOs, IGOs, and host nation capacity is established.

Justice and reconciliation

This section's concerns are establishing public order and safety and providing for social reconciliation. The objective is to help the country establish a self-sustaining public law and order system that operates in accordance with internationally recognized standards and respects internationally recognized human rights and freedoms. This self-sustaining public law and order system must exist inside a safe and secure environment, which initially might have to be provided by the combat force. Civilian organizations have the primary responsibility to work with the host nation to train, advise, and support their efforts to establish a viable rule of law system and facilitate social recovery. The rule of law consists of three related fields: police, judicial, and penal.

- **Police.** To assist in meeting police obligations, the host nation may request that the United Nations (UN) or another nation establish a civilian police (CIVPOL) assistance mission to assist them in community policing. CIVPOL responsibilities encompass a wide range of activities that can be broadly categorized as follows: advising and reporting; reforming and restructuring local police services; training, mentoring, skills transfer, and policy capability enhancement; and performing executive law enforcement functions as authorized. However, when the indigenous security and police forces are nonexistent, incapable, or obstructionist and the CIVPOL cannot generate sufficient capacity quickly enough, the combat force may assist in establishing public order. The combat force has limits because it possesses neither the capacity nor the capability for community policing. The CIVPOL is a separate component of the combat force's mission. The combat force must work closely with the CIVPOL, and both must understand each other's exact authority. The combat force commander may require the addition of gendarmerie type units (not a U.S. capability). The gendarmerie mission includes such tasks as deterring civil disturbances, controlling riots, and collecting and analyzing criminal intelligence. Special police units to participate in high-risk arrests or close protection of very important persons and election candidates may be required.
- **Judicial.** The U.S. Department of Justice, along with the Department of State (DOS), U.S. Agency for International Development (USAID), and the IGOs will lead the efforts to build judicial capability and capacity. The combat force may assist in establishing a workable judicial system with judge advocate and civil affairs functional specialty support. Until the host nation judicial system is functional, international courts and tribunals may be responsible for post-conflict justice.
- **Penal.** When establishing a working penal system, the host nation, in concert with international advisors, should establish standards and rules of confinement in accordance with applicable international instruments, norms, and standards. Although IGOs may assume the responsibility to assist in training host nation personnel in detention operations, the combat force may have to support such activity by designing and conducting training packages, providing technical advice, and supporting the development of institutional capacity operationally and administratively. In emergency situations, the combat force commander may establish and run temporary confinement facilities until civilian

agencies generate sufficient capability and capacity. Leaders should consider deploying the appropriate occupational specialties for confinement duties.

Applicable law. Agreement among the parties as to the applicable law is a key step in establishing rule of law. Organizations (multinational, interagency, or IGO) must review and assist in the development of a penal code to ensure its conformity with appropriate minimum international standards. There may be a period of time where the applicable law is in flux, and commanders and administrators at all levels must remain flexible.

Reconciliation. The process of seeking justice through legal procedures may be more important in building respect for the rule of law than the meting out of summary justice. The tasks of promoting justice, psychological relief, and reconciliation are challenging and time-consuming, but the end goal of achieving reconciliation will lead to a sustainable peace. Areas of consideration include:

- Supporting resettlement and land reform to allow safe passage and safe return.
- Monitoring human rights in the new security organizations and providing human rights training for new defense structures.
- Reporting human rights violations and working to prevent further abuse.
- Protecting social, civil, and cultural rights within the limits of the mandate.

Governance and participation

The establishment of governance and a workable administration leading to a civil society is the responsibility of the host nation. However, the combat force must be prepared, in the short run, to establish a military government, if warranted, or to provide short-term support to an established host nation government or interim government sponsored by the UN or other IGO. The main goal for the military is to create an environment conducive to stable governance. Civil agencies will reestablish the administrative framework, support national constituting processes, support political reform, and establish/reestablish civil society.

Economic stabilization and infrastructure mission

Civilian agencies have the lead responsibility for this mission sector, but the combat force may render support during the emergency phase of infrastructure restoration. Infrastructure restoration consists of reconstituting power, transportation, communications, health and sanitation, fire fighting, education systems, mortuary services, and environmental control. This mission sector includes restoring the functions of economic production and distribution. Though the host nation has primary responsibility, it is incumbent upon outside reconstruction actors (both military and civilian), especially early in stability operations, to:

- Reestablish emergency critical infrastructure (for basic services such as transportation and health systems) to prevent loss of life and the spread of instability.
- Provide limited targeted advice to host nation agencies.
- Help the host nation restore employment opportunities, reestablish commerce, initiate market reform, mobilize domestic and foreign investment, supervise monetary policy, and rebuild public structures. This should be a pure host nation responsibility, supported by U.S. government (USG) interagency, with numerous IGOs, NGOs, and other implementing partners involved. IGOs such as the World Bank provide financial management and technical assistance to economically depressed countries through its International Development Association to bolster economic growth and improve living conditions. However, USG civilian agencies must be prepared to undertake responsibility for tasks in this area in the absence of viable host nation institutions.

Public diplomacy and information operations

This critical mission cuts across all five of the previously outlined mission sectors. Public diplomacy actions are civilian agency efforts to promote an understanding of the reconstruction efforts, rule of law, and civic responsibility through information and international public diplomacy operations. Its objective is to promote and sustain consent for reconstruction both within the host nation and externally in the region and in the larger international community. Civilian agencies conduct educational and cultural exchanges, information activities, and local training and education of indigenous media, as well as assist in developing the local information infrastructure.

Reconstruction Considerations

Command and control

In reconstruction, civilian organizations have the responsibility and the lead. Therefore, command and control or rather the harmonization among the various civil entities and the military must be clearly understood and coordinated. To achieve a holistic approach to reconstruction requires communications and understanding among the various centers, commissions, staffs, augmentations, field offices, and agencies. Complicating these efforts are varying national perspectives regarding the mandate and the resulting mission interpretation. Whereas the U.S. could interpret the mission in terms of force protection, liaison, and limited direct support, another country could view the same mandate in terms of strict neutrality and mediation or one of observation, interposition, and transition assistance.

Additionally, there will be various interpretations of the operational environment among the military, civilian agencies, host nation, NGOs, IGOs, and others. All agencies must understand all of these positions and maintain lines of communication to resolve issues as they arise. There should be a synchronization process. Lines of coordination should be determined based on the reconstruction mission sectors described above. Objectives and desired/undesired effects should be determined for each line of coordination and linked to overall diplomatic, information, military, and economic considerations.

End state conditions and the criteria for success

The U.S. or internationally agreed upon end state for conflict transformation in the country may be general or broad in nature and may stretch well beyond the reconstruction period. Furthermore, much of what goes on under the name of reconstruction includes aspects of development. Reconstruction and longer-term development are a continuum. These realities make it difficult to determine when reconstruction ends and longer-term development begins. Therefore, a requirement exists to determine the end state conditions and criteria for success in a reconstruction operation or effort. These criteria describe the relevant and measurable standards against which attainment of the end state conditions can be determined. The criteria should be developed through a collaborative planning process with both military and civilian agencies. The criteria should relate to the agreed-upon end state for conflict transformation in the country, as well as the reconstruction efforts themselves and should take into consideration the local and cultural realities of the host nation.

Transition to civil authority. The relationships established in the initial stages of the combat operation coupled with accurate assessments of progress achieved in civil-military implementation are crucial to effecting a smooth transition to civil authority. Collaborative planning should be done as early as possible to include the U.S.; multinational partners; IGOs; the host nation, if possible; and NGOs, as appropriate. The transition plan should rest on a complete understanding of the capabilities, responsibilities, and resources of all participants. The result should be an agreed-upon glide path, including measures of effectiveness and resources, which results in decreasing military involvement and increasing civil involvement. Transitions can occur at different times and in different parts of the host nation.

Section III: Commanders' Emergency Response Program (CERP)¹¹

The following extract is from Department of Defense (DOD) Financial Management Regulation, Volume 12, Chapter 27, September 2005.

Purpose and Applicability

The DOD Financial Management Regulation implements the Ronald W. Reagan National Defense Authorization Act for Fiscal Year 2005, Public Law 108-375, section 1201, by assigning responsibilities for administering the Commanders' Emergency Response Program (CERP); defining the purposes for which U.S. appropriations or other funds provided for the CERP may be expended; and specifying the procedures for executing, managing, recording, and reporting such expenditures.

This guidance applies to all organizational entities within DOD. A requirement to comply with this guidance shall be incorporated into contracts, as appropriate. It covers the execution, management, recording, and reporting of expenditures of U.S. appropriations and other funds made available for the CERP.

The CERP is designed to enable local commanders in Iraq and Afghanistan to respond to urgent humanitarian relief and reconstruction requirements within their areas of responsibility by carrying out programs that will immediately assist the indigenous population. The CERP may be used to assist the Iraqi and Afghan people in the following representative areas:

- Water and sanitation
- Food production and distribution
- Agriculture
- Electricity
- Healthcare
- Education
- Telecommunications
- Economic, financial, and management improvements
- Transportation
- Rule of law and governance
- Irrigation
- Civic cleanup activities
- Civic support vehicles
- Repair of civic and cultural facilities
- Repair of damage that results from U.S. coalition, or supporting military operations and is not compensable under the Foreign Claim Act
- Condolence payments to individual civilians for the death, injury, or property damage resulting from U.S. coalition, or supporting military operations
- Payments to individuals upon release from detention
- Protective measures, such as fencing, lights, barrier materials, berming over pipelines, guard towers, temporary civilian guards, etc., to enhance the durability and survivability of a critical infrastructure site (oil pipelines, electric lines, etc.)
- Other urgent humanitarian or reconstruction projects

Responsibilities

Under Secretary of Defense (Comptroller) (USD(C)). The USD(C) shall establish and supervise the execution of principles, policies, and procedures to be followed in connection with the CERP and ensure that congressional oversight committees are timely informed of CERP activities through the quarterly reports required under subsection (b) of the Ronald W. Reagan National Defense Authorization Act for Fiscal Year 2005, Public Law 108-375, section 1201.

Secretary of the Army. Pursuant to DoD Directive 5101.1, “DoD Executive Agents,” dated September 23, 2002, the Secretary of the Army shall serve as executive agent for the CERP and in that capacity shall promulgate detailed procedures as necessary to ensure that unit commanders carry out the CERP in a manner consistent with applicable laws, regulations, and this guidance. These procedures shall include rules for expending CERP funds through contracts and grants in accordance with paragraph 270308 below.

Commander, U.S. Central Command (USCENTCOM). The Commander, USCENTCOM shall determine the appropriate allocation of CERP funds between commands and advocate for appropriate resources and authorities in support of the theater’s military global war on terrorism mission.

Procedures

Proper usage of funds. Appropriated funds made available for the CERP shall not be used for the following purposes:

- Direct or indirect benefit to U.S. coalition or other supporting personnel
- Providing goods, services, or funds to national armies, national guard forces, border security forces, civil defense forces, infrastructure protection forces, highway patrol units, police, special police, or intelligence or other security forces
- Entertainment
- Except as authorized by law and separate implementing guidance, weapons buy-back programs, or other purchases of firearms or ammunition
- Reward programs
- Removal of unexploded ordnance
- Duplication of services available through municipal governments
- Salaries, bonuses, or pensions of Iraqi or Afghan military or civilian government personnel
- Training, equipping, or operating costs of Iraqi or Afghan security forces
- Conducting psychological operations, information operations, or other U.S. coalition, or Iraqi/Afghanistan Security Force operations

Amount. The CERP is intended for small-scale, urgent, humanitarian relief and reconstruction projects for the benefit of the Iraqi and Afghan people. Army shall separately notify USD(C) and CENTCOM J8 of all individual CERP projects of \$500,000 or greater during the normal monthly reporting process. Such separate notification shall include a description of the project, an estimated length of completion, and a justification of how the project supports the purpose of the CERP.

Commingling of funds. Consistent with Volume 5, Chapter 2, “Disbursing Officers, Officers and Agents,” of this Regulation, U.S. appropriations made available for the CERP shall not be commingled with nonappropriated funds and shall be separately executed, managed, recorded, and reported.

Allocation of funds. The USD(C) shall ensure that DOD appropriations and other funds available for the CERP are properly allocated to Army for funds control and execution. Commander, USCENTCOM will notify Army of the appropriate intertheater allocation.

Delivery, transporting, and safeguarding of funds. Any funds made available for the CERP shall be delivered, transported, and safeguarded consistent with Volume 5, Chapter 3, “Keeping and Safeguarding Public Funds.”

Appointment of paying agents. Paying agents responsible for making disbursements of funds under the CERP shall be appointed consistent with Volume 5, Chapter 2, of this regulation.

Documentation of payments. Payments under the CERP shall be made and documented consistent with Volume 5, Chapter 11, “Disbursements,” and Volume 10, Chapter 9, “Supporting Documents to Payment Vouchers,” of this regulation.

Contracts and grants. U.S. appropriations and other funds made available for the CERP may be expended through contracts and grants that are prepared and executed in accordance with regulations designed to ensure transparency, fairness, and accountability. To the maximum extent practicable, these regulations shall be consistent with Coalition Provisional Authority Memorandum Number 4, Contract and Grant Procedures Applicable to Vested and Seized Iraqi Property and the Development Fund for Iraq, dated August 19, 2003.

Circumventing limits. Monetary limits and approval requirements may not be circumvented by “splitting” a single project through the submission of multiple purchase requests or similar documents, or otherwise.

Clearance of accounts. Accounts maintained under the CERP shall be cleared consistent with Volume 5, Chapter 2, of this Regulation.

Certification of payments. Payments made under the CERP shall be certified in a manner consistent with Volume 5, Chapter 33, “Accountable Officials and Certifying Officers.”

Audits and program reviews. The administration of the CERP will be subject to periodic audits by DOD’s internal review and audit organizations, including the DOD Inspector General and the Army Audit Agency, as well as external organizations such as the Government Accountability Office and congressional oversight committees. All officials responsible for administering the CERP shall cooperate fully with any review, audit, or investigation conducted by such organizations.

Reports and Notifications

Not later than the fifteenth day of each month, Army shall submit to the USD(C) a CERP Project Status Report as of the last day of the preceding month. The Army

will provide a copy of the report to USCENTCOM J8 and the Joint Staff, J8. The CERP Project Status Report shall contain the following information by project category:

- Unit
- Project Number
- Payment date
- Description, amount, and location of project
- The amount committed, obligated, and disbursed for the project

Note: This reporting requirement applies only to appropriation-funded CERP for Iraq and Afghanistan under the scope of this guidance and is in addition to the separate monthly requirement to report cumulative totals allocated, committed, obligated, and disbursed for all types of CERP funds in Iraq.

Army, with the support of USD(C), shall be responsible for submitting to Congress the quarterly reports required under Ronald W. Reagan National Defense Authorization Act for Fiscal Year 2005, Public Law 108-375, section 1201.

Army, in coordination with Commander, USCENTCOM, shall promptly notify the USD(C) and the DOD General Counsel of any provisions of law that (if not waived) would prohibit, restrict, limit, or otherwise constrain the exercise of the authority provided by, Ronald W. Reagan National Defense Authorization Act for Fiscal Year 2005, Public Law 108-375, section 1201.

Waivers

Request for waivers or exceptions to any provision of law that would (but for the waiver) prohibit, restrict, limit, or otherwise constrain the execution of the CERP must be submitted through the USD(C) and DOD General Counsel to the Secretary of Defense for approval.

Requests for waivers or exceptions to this guidance must be submitted to the USD(C) for approval.

Section IV: How to Operate as a Team

Concept of Integration

Integration is critical to developing a cohesive team. Because a PRT is composed of so many individuals from different agencies, it can be challenging to work together. One of the keys to establishing good team communication is to integrate all members within the PRT. In order to succeed, PRTs must become truly integrated civil-military structures and not just military organizations with “embedded” civilian advisors or bifurcated organizations with two separate components (military and civilian) that operate separately from one another. In its most evolved and successful state, a PRT is an integrated civil-military team possessing well-organized and coordinated capabilities and functions, such as strategic planning, operations, outreach, and force protection.

Better integration can be achieved when everyone works in the same building. Integration can also be fostered at a deeper level when all groups are task organized by function instead of by agency. In this scenario, a military member, a DOS employee, and a USAID employee could work in the same office. As a result of tight integration or even just having members share workspace, functional sections are more effective and communications are improved. Having military and civilian personnel mix in the various teams can help cross-explain issues. It may take time to reach this level of integration, but a PRT is significantly more productive in an integrated environment within the same building.

Operating as a Team of Equals

PRTs are most successful where military and civilian officers function as a team of equals. Jointly facing the daunting challenges present in extremely insecure environments yields significant benefits such as improved decision making; increased flexibility in a rapidly changing environment; greater involvement; and, therefore, a shared sense of ownership of the outcomes and improved quality of projects and programs. In the absence of an effective team, PRT activities have tended to be *ad hoc* and dominated by tactical concerns, particularly in areas of extreme instability.

In order for the PRT model to be successful, civilian and military representatives must act as full partners, with activities coordinated to allow projects to benefit from each agency's comparative advantage. For example, military decisions to move PRTs or collocate them with a battalion task force need to be coordinated with participating civilian agencies. The current lack of consultation in this type of situation reinforces the perception that the military has the lead for all activities in the area. A PRT is most effective when both the civil and military components understand that they are complementary and work together as a mutually supportive team.

Ideally, PRT operations are informed by doctrine that clearly defines civilian and military roles and responsibilities. However, in the absence of a joint doctrine delineating respective responsibilities, civilian and military members of the PRT must work to develop a shared vision and common understanding of their roles, organization, and mission.

Identifying Different Strengths

The civilian and military staffs contribute different skill sets and capabilities to the PRT. For example, the military brings planning and logistics capabilities, communication equipment, and the ability to secure areas. The civilian agencies bring subject matter experts in the areas of humanitarian assistance, reconstruction, and development strategies and programming. PRT members should recognize what each individual brings to the mission, as well as the expertise their agency provides. Each member should see how his skills and his agency's skills complement the skill sets of other PRT members. Together, the civilian and military components of the team create a shared platform that serves as a critical link between their respective organizations, enabling a more creative application of the full range of USG expertise to address the identified host-country needs in semi-permissive and remote environments.

Team Building and Establishing Shared Goals

In order to develop a common operating vision informed by shared operational guidelines members of the PRT should invest in team-building activities that establish and develop a greater sense of collaboration and mutual trust within the team. Critical reforms of the PRT system that enhance team collaboration and coordination, such as team predeployment training and synchronization of lengths of tour between the military and civilians, is beyond the guidance issued here.

Once deployed to a PRT, it is advisable to manage expectations by understanding the generic stages of team development (forming, storming, normalizing, and performing) and to recognize that the PRT operates under extreme stress (environment, timelines, and ambiguity) that affects these team cycles. Even so, as a team, PRT members should clearly establish shared goals, missions, and objectives; distribute the workload appropriately; and work to balance the variable skill sets represented at the PRT, matching skills to specific missions and objectives. When a PRT member is able to identify with a broader goal than a job description alone, he is more willing to contribute and assist others with their work.

Leaders often develop personal mission statements and set goals. Although a formal mission statement for the PRT exists, it can be helpful for PRT members to work with the PRT leader to devise a personal mission statement, which can help provide both team unity and individual focus.

The Maneuver Command and the PRT

The maneuver command and the PRT each has its own objectives. The maneuver command is concerned with separating insurgents from the population within a province, constraining insurgent operations, and defeating insurgents in conventional operations. The PRT augments the counterinsurgency mission by filling the gaps for these elements which are traditional and non-military. Keys in this effort are to improve governance and basic services. In Afghanistan, this is done in the context of extending the authority and capacity of the central government in each province and linking government to communities within each district. In Iraq, this is undertaken through capacity building at the provincial level. However, the goals of the maneuver command and PRT often overlap and, in this situation, their activities should complement each other. For example, the maneuver command may try to expand the short-term employment of men between ages 16 and 35 through an irrigation repair program to dissuade them from joining the insurgency. The PRT develops agricultural business opportunities to improve livelihoods and create sustainable long-term employment. These types of overlaps should be identified and built upon in program planning and implementation.

Establishing Appropriate Framework and Standing Operating Procedures (SOPs)

Members of the PRT should immediately establish a framework of the respective roles, relationships, and resources of the involved agencies in SOPs. These SOPs provide a structure for building greater interagency consensus and for establishing agreed-upon mission-essential tasks for each PRT, without imposing unrealistic constraints. For example, a shared framework or SOP provides a road map for reaching consensus on project approval, funding allocation, and other key decision-making issues. It also incorporates a wide range of response options for managing these and other decision-making issues within different operating

contexts (e.g., nonpermissive, insecure, remote, and ungoverned) as the situation in a PRT's area of responsibility changes.

Civil Affairs (CA) Teams and the PRT

CA teams assigned to brigades can be used more effectively and be better integrated into PRT operations. One suggestion is to deploy a CMO/CA planning team (brigade CMO officer, CA company commander, and operations staff) from the brigade and its incoming CA support about 30 days prior to full company deployment. This procedure allows the planning team to work with the PRT to define goals or redefine existing strategies based on the skill sets available in the CA company. It also gives CA leaders the chance to understand the provincial environment, as well as to get to know PRT colleagues and procedures.

Overall, this deployment helps the integration of the functional planning team members into the larger PRT team and improves synergies between PRT actions and the maneuver commander's actions. The CMO staff and CA leaders are also better equipped both to educate the incoming CA company on their duties and to facilitate their PRT integration in the shortest possible time. The brigade CMO officer continues to be responsible for meshing the PRT's goals, objectives, and plans with its capabilities.

Section V: Information Sharing

“Organizations have contrasting objectives, strategies for reaching their goals, and measures of success, all which contribute to misunderstanding and distrust. Even when actors overcome ideological, language, and professional barriers, other obstacles, such as competition over limited resources, remain.”

–Rebecca Linder, *“Wikis, Webs, and Networks: Creating Connections for Conflict-Prone Settings”*

Effective information sharing in the context of a reconstruction operation or crisis response requires far more than simply keeping all relevant parties “in the loop” and can be facilitated by creating joint platforms, such as a PRT, that foster joint and integrated planning (training, developing a common vocabulary to describe the work, and a common understanding of operational procedures in the field) from the earliest stages. While there are general “best practices” for information sharing, success ultimately depends on developing common understanding and ownership of the information that is being shared. This section addresses general issues and institutional challenges, stakeholder needs, and tools and guidelines for internal and external information sharing.

General Issues and Challenges

Individual agency policies

Learning to work with multiple agencies and organizations is a way of life for the PRT leadership. There is a wide array of actors involved in a stabilization and reconstruction effort, both within a PRT and outside a PRT. However, these actors do not always have an effective means of communicating with each other. Past PRT

officials have expressed that they were often uninformed about other U.S. organizations' related programs and activities underway within their provinces.

Agency protocols can sometimes act as impediments, and many segments within and between communities can sometimes be reluctant or unable to share information. In addition, PRT members have limited time and overwhelming responsibilities. PRT members should nonetheless strive to establish a sense of connectivity and open communication. The fast-paced, chaotic environments in which PRTs operate make openly sharing new ideas and information more useful than the traditional practice of closely managing information flow through established hierarchies. When possible, PRT members should, as a community, openly generate, share, and interpret content.

Content

Are we speaking the same language? Agency acronyms and using terminology and cross-cultural communication are the basis for many of the initial misunderstandings that occur between PRT members. PRT members should anticipate a lack of common terminology while carrying out post-conflict activities.

Interoperability is another oft-cited problem

Incompatible radio systems, for instance, can hinder civilian-military communications. Other examples are organizations that conduct assessments or create databases without attempting to find a way to share such information.

Clearance and classification

Each agency has its own line of authority or command through which its information products must be cleared. The key to effective information sharing is to understand.

Classification issues pose another significant challenge to interagency information sharing. There are differences in classification thresholds applied by the military and civilian agencies and differences between civilian agencies on how or when information is classified. There are also significant differences in capabilities between DOD, DOS, and USAID to handle, store, and transmit classified information, both in the field and at headquarters. While USAID works primarily in an unclassified setting with limited classified network access and storage capabilities at headquarters and in some field missions, DOS has classified and unclassified facilities in every embassy, as well as fairly easy access at headquarters. DOD has the full range of headquarters and field capabilities, with secure network equipment and procedures for creating and working with classified information at every level.

These disparities can create difficulties on two levels: 1) Technical difficulties in communicating classified information from person A to person B and in having timely follow-on actions in response to actionable information; and 2) Disagreements about whether and at what level to classify information. Both disparities have an immediate impact on how easily and quickly information can be shared and acted upon for operations/programming by recipient agencies.

General Tips for Information Sharing

Here are some general suggestions for juggling different relationships and communicating efficiently and effectively:

- Build and maintain momentum (keep distractions out of the way).
- Understand what you are doing and how it fits into the overall picture.
- Communicate down the chain.
- Draw on the skills of fellow PRT members.
- Build relationships with the various stakeholders.
- Do not make changes at the beginning unless absolutely necessary. It is better to make minor adjustments to keep the momentum going.

Although hierarchies exist in the functioning of a PRT, members should try to rely on “networks” as much as possible. Networks are defined broadly as the connections between people and organizations and have a degree of flexibility and interdependence. Networks permit both vertical and horizontal flows, as well as direct exchange between practitioners. Information sharing through networks is more appropriate in conflict-prone settings than hierarchies.

Even in the context of a hierarchy, networks can be invoked to enable lateral connections and improve effectiveness. For example, military members can share firsthand tactical experiences by utilizing the Joint Knowledge Online PRT Site at <http://jko.jfcom.mil> or the Battle Command Knowledge System at <https://bcks.army.mil>. Even when organizations are reluctant to coordinate or share information, individuals can, under appropriate circumstances, work around institutional boundaries and share information.

In order for stabilization and reconstruction to be successful, all individuals and organizations must be able to connect, share information, and coordinate. PRTs function best when they are truly user-driven, meaning all individuals contribute information, share concepts, and evaluate resources transparently. This applies to the inner workings of a PRT and how PRTs interact with outside stakeholders.

Remember, communication is often a social, not a technical, problem.

Endnotes

⁶ This section derived from the *ISAF Provincial Team Handbook*, v3, Feb. 2007.

⁷ Oxford English Dictionary.

⁸ **Narco-crime.** Organized narco-crime flourishes in the absence of effective security institutions and judicial frameworks and a country awash with surplus weaponry and weak governance. The narcotics industry also provides financial support for terrorist groups and factional commanders. Narcotics production may become a way of life for many, particularly in the absence of alternative livelihoods. The production and transportation of narcotics is closely protected.

The farmers receive less than 20 percent of the drug revenue. The rest goes to traders, traffickers, commanders of illegally armed groups, and corrupt government officials. Fighting narcotics requires a national and international effort to manage demand as well as supply.

Banditry. Individuals and/or armed groups are opportunistically taking advantage of the absence of effective security institutions. There is a lack of reintegration programs, as well as a viable economy in rural areas.

Warlordism and factionalism. Many parts of the world live in tribal societies. They traditionally retain weapons for self-protection in the absence of state security. When a host country has limited influence in the provinces, its accommodation of local power brokers have left factional chiefs in control of local government. Coalition forces may empower factional commanders to aid in stabilization; however, this contributes to the fragmentation of power and frustrates the reform process. The host nation or coalition forces may successfully reduce the power of some warlords by reassigning them away from their geographical power base, but their networks continue to influence provincial administration. However, former commanders in government positions in the police and civil administration may bring with them their often-unqualified supporters as few alternatives exist for them. Warlords regularly seize vehicles, livestock, and cash as taxes and payment for protection. Warlords leverage their power and influence to gain control of customs posts, bazaars, and narcotics trafficking.

⁹ LTC Antulio J. Echevarria II, "Reigning in the Center of Gravity Concept," *Air and Space Power Journal*, Summer 2003.

¹⁰ This section is derived from Joint Publication 3-07.3, *Peace Operations*, June 2007 (revision final coordinating draft).

¹¹ *Financial Management Regulation*, DOD, Volume 12, Chapter 27, September 2005.

Annex B

Afghanistan Provincial Reconstruction Teams

This annex is the U.S. complement to the *International Security Assistance Force (ISAF) Provincial Reconstruction Team (PRT) Handbook*. Except as noted below and where situations dictate otherwise, the ISAF Handbook should be the primary source of information, policies, and practices used by U.S. PRTs and members assigned to a PRT, U.S., or coalition in Afghanistan.

PRT Management and Structure

Key interagency components from Washington, D.C., to Kabul, Afghanistan

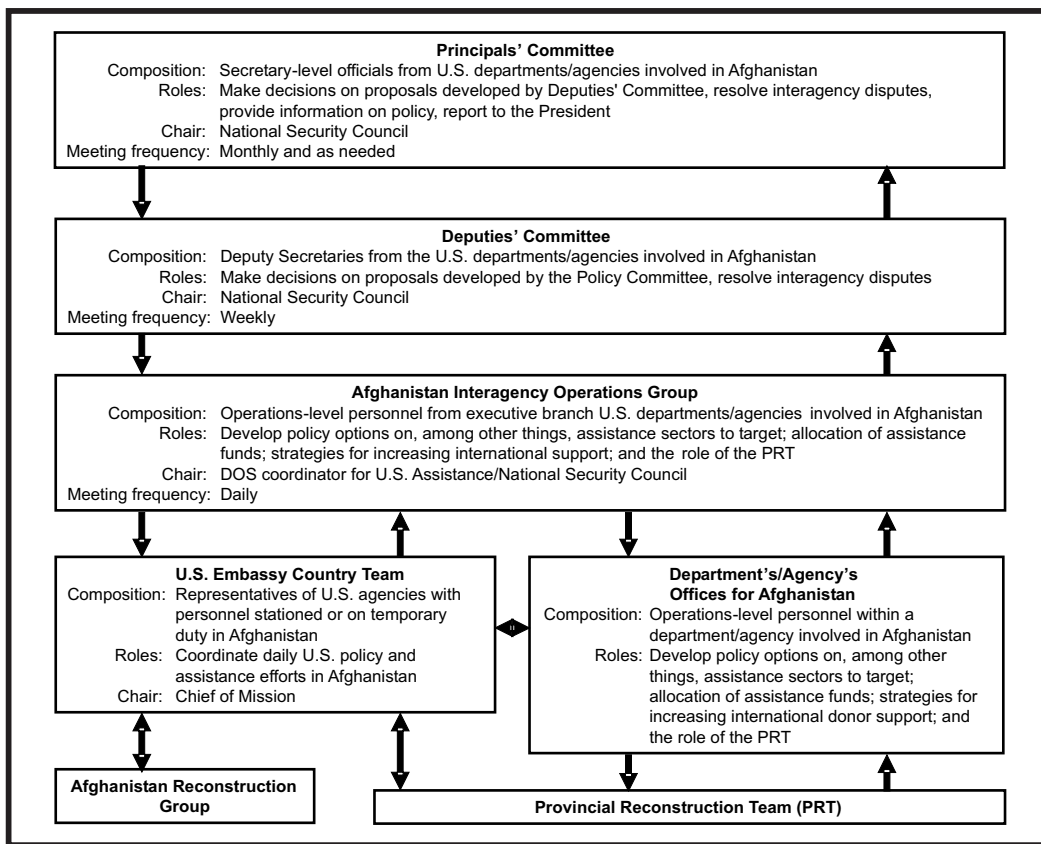

Figure B-1: Major U.S. interagency Afghan assistance coordination mechanisms¹²

Key interagency decisions for U.S. PRTs within Afghanistan are coordinated primarily through daily meetings of the Afghanistan Interagency Operations Group. The group includes representatives from the Department of State (DOS), U.S. Agency for International Development (USAID), Department of Defense (DOD), and other agencies delivering assistance. This formal interagency committee provides a uniform process for making and informing the President of policy-level decisions and for sharing information among agencies. In Afghanistan, U.S. assistance is coordinated through the U.S. embassy country team, although certain

CENTER FOR ARMY LESSONS LEARNED

funding processes, such as CERP, may be executed at the discretion of the commander. (See Figure B-1.)

DOS and DOD created the Afghanistan Reconstruction Group (ARG) in fiscal year (FY) 2004. This group is based in the U.S. embassy in Kabul, Afghanistan, and is a nontraditional solution to a nontraditional challenge. The ARG consists of a specially recruited group of senior advisors drawn from the highest levels of the private and public sectors, who bring their expertise in reconstruction-related skills, drive, and accountability to the reconstruction efforts in Afghanistan. The group reports directly to the U.S. ambassador and coordinates with and assists officials at the highest levels of the Afghan government. Senior advisors provide a critically important strategic and private-sector perspective on the assistance and reconstruction efforts for Afghanistan. Identification and expansion of opportunities for private sector development are given high priority.

Key military components from Tampa, FL, to Bagram, Afghanistan (See Figure B-2; see the ISAF PRT handbook for a description of ISAF structure.)

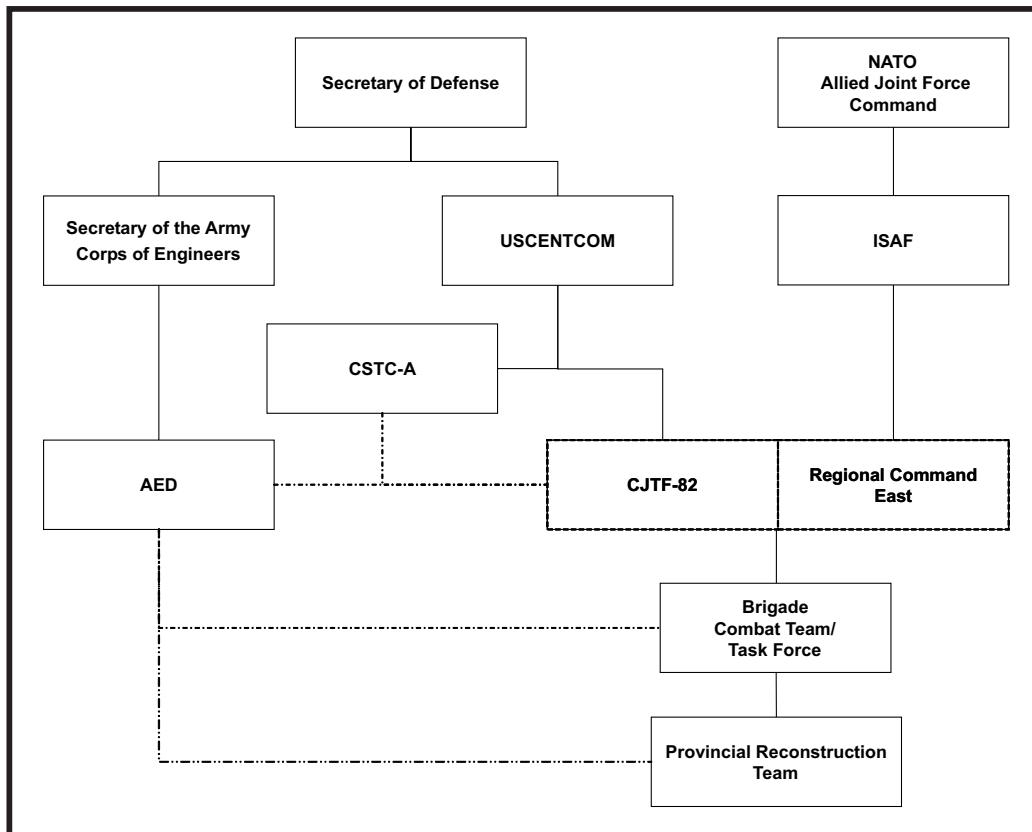

Figure B-2

The United States Central Command (USCENTCOM) is the combatant command authority for military personnel. Its areas of responsibility (AORs) include the Middle East, East Africa, and Central Asia. Its mission is “to conduct operations to attack, disrupt, and defeat terrorism; to deter and defeat adversaries; to deny access

to WMD; to assure regional access; to strengthen regional stability; to build the self-reliance of partner nations' security forces; and to protect the vital interests of the United States within the AOR.”¹³

USCENTCOM has a forward headquarters located in Qatar to serve American strategic interests of the Iraq and Afghanistan region.

Combined Joint Task Force 82 (CJTF-82) was formed in June 2002 as CJTF-180 as the forward headquarters in Afghanistan to serve as the single joint command responsible to USCENTCOM and to the Secretary of Defense for all military functions in the country. CJTF-180 changed in mid-April 2004 to CJTF-76 and in mid-February 2007 became CJTF-82. The mission of CJTF-82 is to conduct full-spectrum operations to prevent the re-emergence of terror organizations and to establish an environment sufficiently stable to facilitate reconstruction, development, and growth of governmental and security institutions in Afghanistan.

The Combined Security Transition Command-Afghanistan (CSTC-A), in partnership with the Government of Afghanistan (GoA) and the international community, plans, programs, and implements reform of the Afghan Police and defense sectors to develop a stable Afghanistan, strengthen the rule of law, and deter and defeat terrorism within its borders.¹⁴

PRT structure

Initial guidance on the structure and functions of U.S.-led PRTs within Afghanistan was agreed to by senior civilian and military leadership in Afghanistan and approved by the U.S. Deputies Committee in June 2003. The guidance envisioned that civilian representatives and military officers in the PRT would work as a team to assess the environment and develop strategies to achieve the three primary objectives.

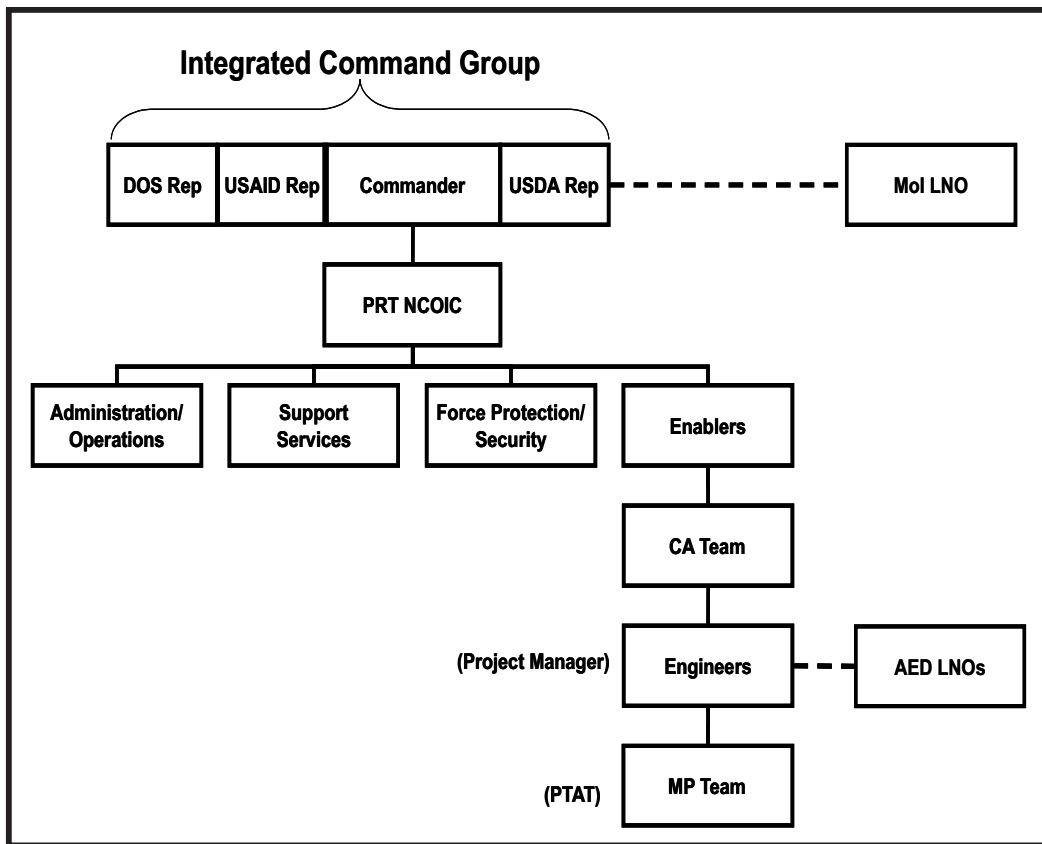

Figure B-3: PRT core task organization

DOD was assigned responsibility for improving security in the PRT’s area of operation, as well as providing all logistical support and providing force protection for all PRT members, including civilians. USAID was given the lead on reconstruction and DOS was responsible for political oversight, coordination, and reporting. All members of the PRT leadership structure—military and civilian—are required to approve reconstruction projects and coordinate with local government offices and national ministries. The concept anticipated that as PRTs matured and conditions changed, additional capacity would be available through reach-back to additional military and civilian assets.

The size and composition of U.S. PRTs vary depending on maturity, local circumstances, and the availability of personnel from civilian agencies. Combined Forces Command-Afghanistan did establish a model, which U.S. PRTs still generally emulate. According to the model, lieutenant colonels/commanders command the U.S. PRTs, which have a complement of military and civilian personnel. There is also an Afghan Ministry of the Interior representative and three to four local interpreters. The model’s civilian component includes representatives from the DOS, USAID, and U.S. Department of Agriculture. (See Figure B-3.)

USAID in Afghanistan¹⁵

Overview

USAID is working with the GoA to build a safe, free, and prosperous future, a country at peace with its neighbors, and a friend to freedom around the world.

USAID assistance (See <<http://afghanistan.usaid.gov/en/Programs.aspx>> for a list of current projects.)

Infrastructure

USAID is funding the construction and rehabilitation of infrastructure critical for further economic development and national integration. The primary focus is roads, including a major portion of the Kabul-Kandahar-Herat highway and approximately 1,000 kilometers of provincial, district, and rural roads. USAID is also investing in the construction and rehabilitation of power plants; transmission lines; dams, irrigation, and flood control systems; industrial parks; bridges; and universities, schools, and clinics.

Economic growth

USAID helped create a more attractive environment for economic growth by providing assistance to the GoA to design and implement sound, sustainable, transparent, and predictable economic policy. This included strengthening fiscal and monetary policy; enhancing revenue and expenditure management; and improving banking supervision and the legal framework for the financial, commercial, and trade sectors. USAID also works directly with the private sector to strengthen competitiveness in domestic and international markets.

Democracy and governance

USAID is supporting Afghanistan's commitment to a representative, broadly accepted national government, capable of promoting national unity and curtailing the role of extremists. USAID is providing logistical and technical support for free and fair elections; helping institutionalize the rule of law; establishing the National Assembly and strengthening the core offices of the presidency, as well as local government; and fostering the development of a viable civil society, including a professionally trained free press and an independent media.

Support for GoA and other cross-cutting initiatives

USAID directly supports GoA and a number of cross-cutting activities such as gender programs, training, PRTs, and the development of information technology.

Alternative livelihoods program (ALP)

ALP provides Afghans with opportunities to participate in the licit economy in key poppy-growing areas. In meeting immediate needs to provide economic opportunity, ALP supports labor-intensive cash-for-work projects to build or rehabilitate productive infrastructure and funds income generating and training efforts for vulnerable households as part of Afghanistan's counter-narcotics strategy.

Health

USAID supports basic health services, especially in rural and under-served areas. Over 660 clinics have been built or refurbished, and the number of people served in the clinics has increased. In coordination with the Ministry of Public Health, USAID has also supported the training of health workers, including doctors, midwives, and nurses, and has supported national tuberculosis, malaria, and avian influenza immunization programs.

Education

Following the defeat of the Taliban, USAID responded to the urgent need for schools, textbooks, trained teachers, and accelerated literacy courses for young women formerly denied an education. In the intervening years, USAID has expanded support to education in Afghanistan to include radio-based teacher training, primary school teacher training, higher education programs, and community-based and remedial literacy training. With the Ministry of Education and communities, over 650 schools have been built or renovated and over-aged students are enrolled in accelerated learning classes and have the opportunity to obtain an education.

Agriculture

USAID supports the development of a market-based licit rural economy that reduces poverty by developing Afghanistan's competitive advantages in agriculture production and diversifying its rural economy. Projects are designed to improve food security, increase agricultural productivity and rural employment, improve the management of natural resources and conserve biodiversity, and increase private sector investment in the agriculture sector.

PRTs

PRTs are civil-military organizations that are designed to improve security, extend the reach of the Afghan government, and facilitate reconstruction in priority provinces. Their core objective is to implement projects that will improve stability so that more traditional forms of development assistance can resume. USAID's programs work with PRTs to deliver services in less secure or under-served areas of Afghanistan. As USAID's primary representative in the provinces, field program officers monitor all U.S. reconstruction and development efforts in the area of responsibility of the PRT and implement PRT-specific programming. The officers work to build relationships with local leaders, identify local needs, and report on significant developments.

Reintegrating former combatants

USAID is working to ensure that reintegration assistance provided to 66,000 former combatants is effective and sustainable.

United States Army Corps of Engineers (USACE) in Afghanistan¹⁶

Overview

USACE provides quality responsive engineering and construction services to a variety of customers through its Afghanistan Engineer District (AED). AED

performs a crucial role in the international efforts to facilitate establishing a secure and stable environment in Afghanistan, while promoting reconstruction and infrastructure development.

More than 200 U.S. civilian and military personnel are assigned to AED. They manage programs and projects that support a full spectrum of regional activities for the ISAF, CSTC-A and CJTF-82, USAID, and other organizations operating in Afghanistan.

USACE assistance (See <<http://www.aed.usace.army.mil/programs.asp>> for a list of current projects.)

These efforts generally fall into four major program areas:

- **Afghan National Security Forces Program:** CSTC-A acts in partnership with the GoA and the international community to plan, program, and implement reform of the Afghan police and defense sectors to strength the rule of law and deter terrorism within the borders. USACE contributes to the Afghanistan Security Forces Program by designing and constructing facilities for the Afghan National Army, Afghan National Police, and other defense sectors.

Typical facilities consist of barracks, dining, administration, maintenance, utility systems, and other associated structures to meet mission requirements. To date, AED has completed or has under construction facilities that accommodate more than 50,000 Afghan Army soldiers, and AED has completed more than 100 facilities for the police program, while working toward an end state of nearly 700 facilities.

- **U.S./Coalition Forces Power Projection Program:** Under this program, USACE provides engineering and technical support to DOD and its military construction requirements in Afghanistan. These requirements include runways, airfield facilities, ammunition supply points, military housing, operations centers, and associated infrastructure and utility systems.
- **Counter-Narcotics/Border Management Initiative:** This program oversees the construction of forward operating bases and border crossings, as well as other projects such as the National Investigative Unit, the Judicial Center, and joint aviation facilities in Afghanistan.
- **Strategic Reconstruction Program:** Through this program, the AED staff works with CSTC-A, USAID, donor nations, and agencies to identify areas where projects have an immediate effect in building alternative livelihoods, creating ownership, and eroding enemy support.

Some of the projects are funded by the Commander's Emergency Relief Program and include projects such as water management studies, alternative power initiatives, and construction of national and provincial roads and micro-hydro power stations. Construction is complete on more than 884 kilometers of roads with another 1,434 kilometers projected for FY 2007.

Road projects are critical for two primary reasons. First, they provide improved access for coalition, Afghan National Army, and Afghan National Police forces to ensure security throughout the country. Second, road projects improve access for Afghan people to participate in governance, education, health, trade, and other development projects. In addition, the Afghanistan and Tajikistan governments have commissioned the construction of a 673-meter weathering steel girder bridge. The bridge will support two lanes of commercial traffic, plus pedestrian and cart traffic, and open up a landlocked country to more commercial trade.

Building Afghanistan's national capacity

AED is committed to doing its part to help build Afghanistan's national capacity. On any given day, as many as 14,000 Afghans are at work on corps projects scattered around the country. The number of workers is expected to increase to 20,000 by the summer of 2007 as a result of the AED's increased workload and the initiatives to place more work with Afghan nationals and firms. The number of Afghan construction firms submitting proposals on AED's projects has significantly increased. As of December 2006, 70 percent of AED contract awards went to Afghan or Afghan-American firms.

In addition, more than 120 Afghans work directly for AED; 49 of the 120 are in engineer/supervisory positions. AED engineers also partner and support Afghan facility engineers at various project sites.

AED will continue to provide valuable engineering and construction services to support the development and execution of U.S. and international efforts to establish a secure and stable environment in Afghanistan. USACE estimates that it will manage approximately \$2.07 billion in program funds in FY 2007, a significant increase over FY 2006.

Endnotes

¹² "Afghanistan Reconstruction: Despite Some Progress, Deteriorating Security and Other Obstacles Continue to Threaten Achievement of U.S. Goals," *Report 05-742*, U.S. Government Accountability Office, July 2005.

¹³ USCENTCOM mission statement, <<http://www.centcom.mil/sites/uscentcom2/Misc/Mission2.aspx>>, accessed on July 29, 2007.

¹⁴ CSTC-A mission statement, <<http://oneteam.centcom.mil/default.aspx>>, accessed on July 29, 2007.

¹⁵ USAID/Afghanistan Strategy, <<http://afghanistan.usaid.gov/en/Page.CountryOverview.aspx>>, accessed on July 31, 2007.

¹⁶ <<http://www.aed.usace.army.mil/mission.asp>>.

Annex C

Iraq Provincial Reconstruction Teams

The concept of the provincial reconstruction team (PRT) resulted from a joint initiative between the Multi-National Force-Iraq (MNF-I)/Department of Defense (DOD) and the U.S. Mission Iraq /Department of State (DOS). The intent was to transition the lines of operation of governance and economics at the provincial level from the military to the PRT. PRTs take on the task of developing the political and economic environment within the province.

Mission Statement of PRTs in Iraq

The PRT program is a priority joint Department of State (DOS)/Department of Defense (DOD) initiative to bolster moderates, support U.S. counterinsurgency strategy, promote reconciliation, shape the political environment, support economic development, and build the capacity of Iraqi provincial governments to hasten the transition to Iraqi self-sufficiency.

PRTs may be led by the United States or by coalition partners in Iraq. Currently the United Kingdom (U.K.)-led Basrah PRT, Italian-led Dhi Qar PRT, and the Republic of Korea (ROK)-led Irbil PRT are the only coalition PRTs. The Basrah PRT consists of U.K., Danish, and U.S. personnel; the Dhi Qar PRT consists of Italian, U.K., and U.S. personnel; and the Irbil PRT consists of ROK and U.S. personnel. These PRTs are providing their own life support; however, they have a core of civilian agency, military, and contractor personnel. The DOS serves as the lead agency for all PRTs.

As the title indicates, the focus of PRTs is the provincial government. At the national level, the U.S. has several agencies engaged, including DOD, DOS, and others. Below the provincial government, at the district/city government level, the maneuver commander takes the lead. In the spring of 2007, embedded PRTs were assigned to brigade/regimental combat teams to facilitate the maneuver commanders' interaction at the district/city government level in the Anbar, Baghdad, and Babil provinces. At this same time, all PRTs, with the exception of the Babil PRT, were paired with a brigade/regimental combat team (BCT/RCT) or division/force headquarters.

PRTs in Iraq focus on coaching, teaching, and mentoring Iraqis in governance and economics. The PRT structure is modular in nature, with a standard core structure tailored to each province. The DOS takes the lead for PRTs, supported by DOD and other civilian agencies.

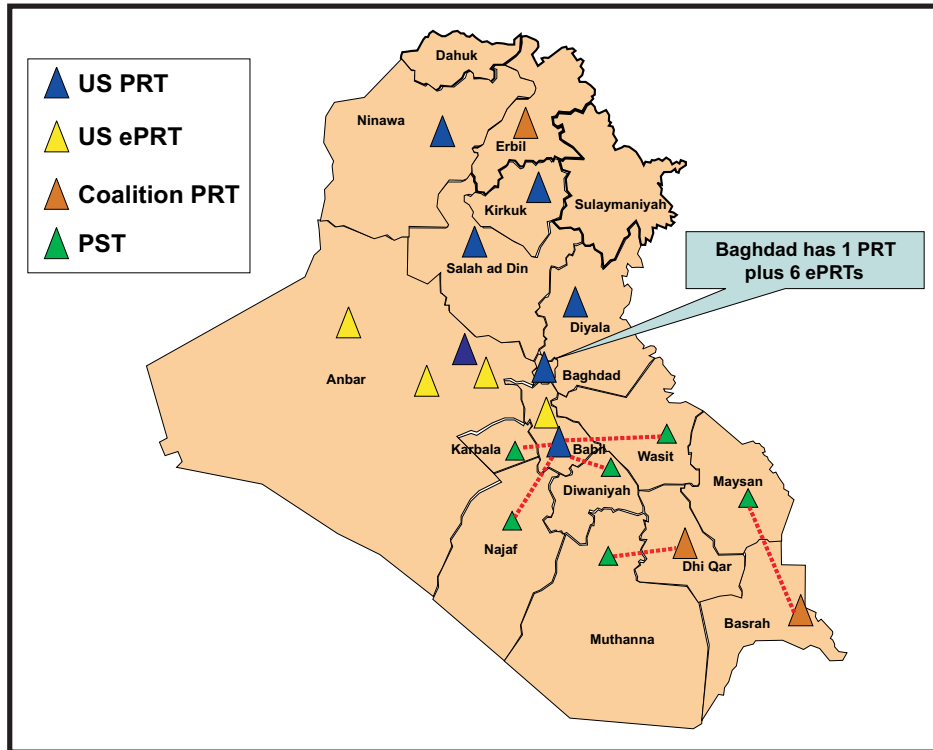

Figure C-1: PRT footprint

PRT Management

Key interagency components from Washington, D.C., to Baghdad, Iraq

Key interagency decisions for U.S. PRTs within Iraq are coordinated primarily through biweekly meetings of representatives from the DOS, U.S. Agency for International Development (USAID), DOD, U.S. Department of Agriculture (USDA), and other agencies delivering assistance. This formal, interagency working group system provides a uniform process for making policy and logistics decisions and for sharing information among agencies. In Iraq, U.S. assistance is coordinated through the U.S. embassy country team with PRT direction emanating from the Joint Executive Steering Committee (an interagency, multinational organization). (See Figure C-2.)

The Office of Provincial Affairs (OPA) is a civil-military organization established by a joint DOS and DOD initiative under the operational guidance of the Joint Executive Steering Committee. The OPA's task is to coordinate the deployment and supervise the civil-military operations of the PRT capacity-building program. The intention of the Joint Executive Steering Committee and coalition is to deploy PRT support to all Iraqi provinces for capacity development. Selected provinces will receive support from a provincial support team from a neighboring province.

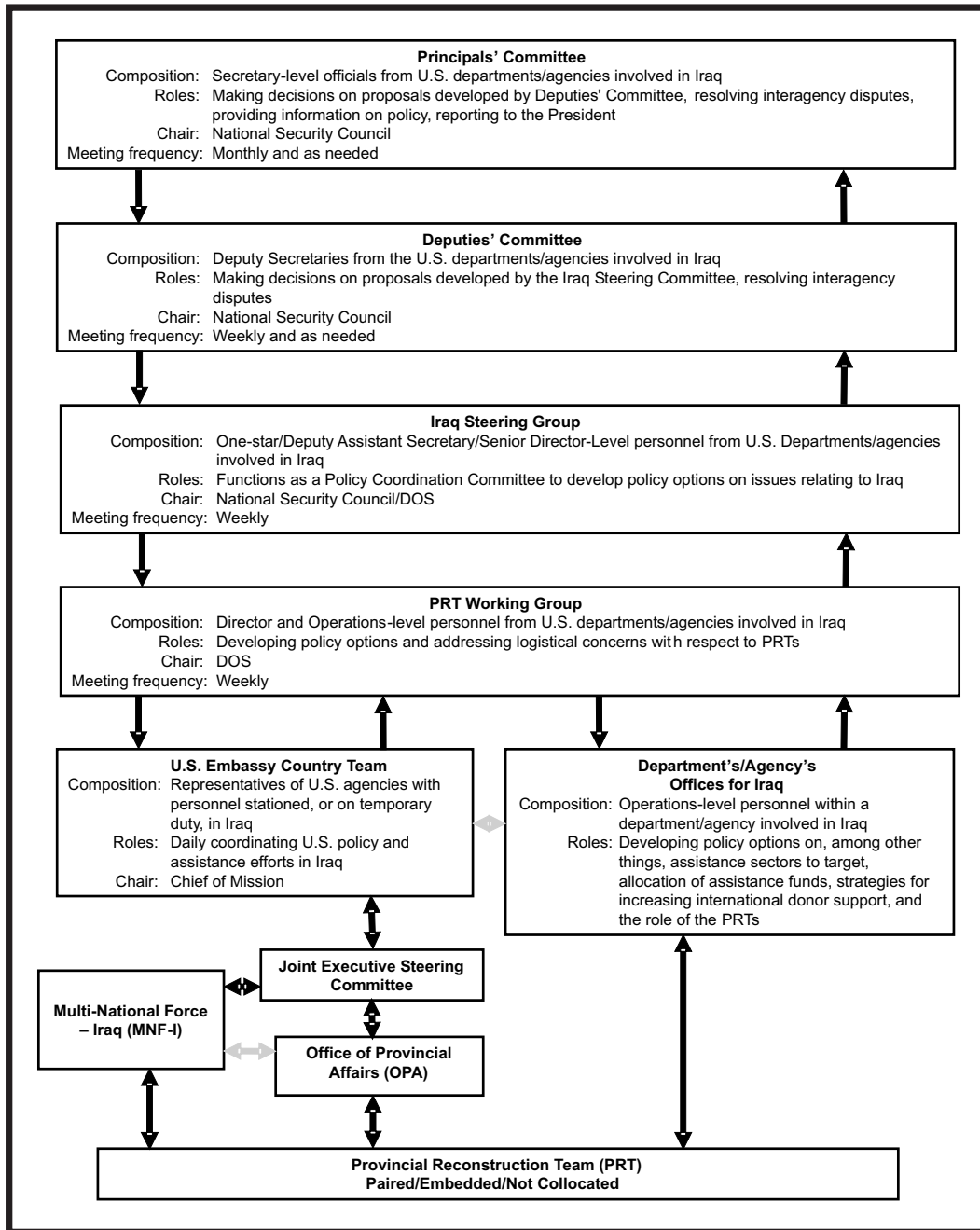

Figure C-2: Major U.S. interagency Iraqi assistance coordination mechanisms

Key military components from Tampa, FL, to Baghdad, Iraq

The United States Central Command (USCENTCOM) is the combatant command authority for military personnel. Its areas of responsibility (AORs) include the Middle East, East Africa, and Central Asia. Its mission is “to conduct operations to attack, disrupt, and defeat terrorism; to deter and defeat adversaries; to deny access to WMD; to assure regional access; to strengthen regional stability; to build the

self-reliance of partner nations' security forces; and to protect the vital interests of the United States within the AOR.”

USCENTCOM has a forward headquarters located in Qatar to serve American strategic interests of the Iraq and Afghanistan region.

MNF-I is one of two military commands that stood up in Iraq in May 2004 to replace Combined Joint Task Force 7 (the other command was Multi-National Corps-Iraq [MNC-I]—see below). MNF-I conducts offensive operations to defeat remaining noncompliant forces and neutralize destabilizing influences in Iraq to create a secure environment. MNF-I organizes, trains, equips, mentors, and certifies credible and capable Iraqi Security Forces to transition responsibility for security from coalition forces to Iraqi forces. Concurrently, MNF-I conducts stability operations to support the establishment of government, the restoration of essential services, and economic development to set the conditions for a transfer of sovereignty to designated follow-on authorities.

MNC-I, a suborganization of MNF-I, is the tactical unit responsible for command and control of operations throughout Iraq. MNC-I is headquartered by the U.S. Army at Camp Victory, Baghdad, and is divided into the following major AORs, maintained by forces from 26 countries plus a logistical support area:

- Multi-National Force-West (MNF-W): MNF-W operates in the western region, including the cities of Ar Ramadi and Fallujah. MNF-W is headquartered by U.S. Marine Expeditionary Forces.
- Multi-National Division-Baghdad (MND-B): MND-B is also known as Task Force Baghdad. Its major AOR is the city of Baghdad.
- Multi-National Division-Center (MND-C): MND-C covers Karbala, Najaf, Babil, Wasit, and North Babil areas.
- Multi-National Division-Central South (MND-CS): MND-CS covers the province of Diwaniyah. The division is headquartered by the Polish military.
- Multi-National Division-North (MND-N): MND-N is responsible for an area including the cities of Balad, Kirkuk, Tikrit, Mosul, and Samarra.
- Multi-National Division-Southeast (MND-SE): MND-SE operates in the southeastern region, including the cities of Basrah, An Nasiriyah, As Samawah, and Al Amarah. The division is headquartered by elements of the British military.
- Multi-National Division-Northeast (MND-NE): MND-NE is centered around Irbil. Its main tasks are to provide medical services and to build and repair roads, power lines, schools, and other public works. The original contingent consisted of combat engineers of the South Korean Zaytun (“olive-peace”) Division.
- Logistical Support Area (LSA) Anaconda: LSA Anaconda is responsible for providing logistical support throughout the theater.

Multi-National Security Transition Command-Iraq (MNSTC-I): MNSTC-I, commonly called “min-sticky,” is responsible for organizing, training, equipping, and mentoring Iraqi Security Forces throughout the country.

Iraq’s Governance Structure

Iraq has a history of a repressive national government under the Ba’ath Party and Saddam Hussein. As a result, the devolution of substantial authority to provincial and district/city governments is a new concept in Iraq. The PRTs are part of the long-term transition plan that will help to decentralize some of the responsibilities from the national government to the provincial government.

National government

On January 30, 2005, Iraq held its first open election and chose members of the transitional 275-member National Assembly, establishing its legislature. Iraq’s national government might be described as a federal parliamentary representative republic, where the prime minister is the head of the government and has the authority to appoint a cabinet for the various ministries, such as the Ministry of Transportation, Ministry of Finance, Ministry of Interior, and so on. Iraq also has a president and two vice presidents; however, most of the power resides with the prime minister. National government is not the focus of the PRTs.

Provincial government

PRTs focus their efforts on the provincial level of government. In the January 2005 election, the people voted for political parties, representatives of which were designated to the Provincial Council (PC). The political parties have a pro-rata share of the seats depending on the election results. Within the PC, 25 percent of the members must be female. Once the PC is elected, it appoints the governor. The governor or the chairman of the PC is important to the provincial government’s success.

Within the provinces, each ministry that has relevant matters may have a director general (DG) who is responsible for various functions. For example, the Ministry of Transportation is responsible for airports. Therefore, if an airport is located within the province, there would be a DG who serves the district. Presently, there appears to be no link between the DGs and the PCs.

District/subdistrict/city government

Within each province there exist districts/municipalities where local councils serve their respective communities. In support of the military surge in Baghdad and Al Anbar province and in coordination with the PRT-Baghdad and PRT-Ramadi, the newly established embedded PRTs (ePRTs) work at the subprovincial level assisting districts and municipalities in reconnecting with their provincial governments. They also empower moderates in local government, business, and civil society. This has been particularly pronounced in Al Anbar where the return to government control has seen the re-emergence of subprovincial government.

PRT Structure

Nominal PRT

Because PRTs are modular in nature, staffing may vary in number of personnel, including civilian, military, and contractors. PRTs task-organize their respective PRTs based on their mission, so the structure of each PRT may vary.

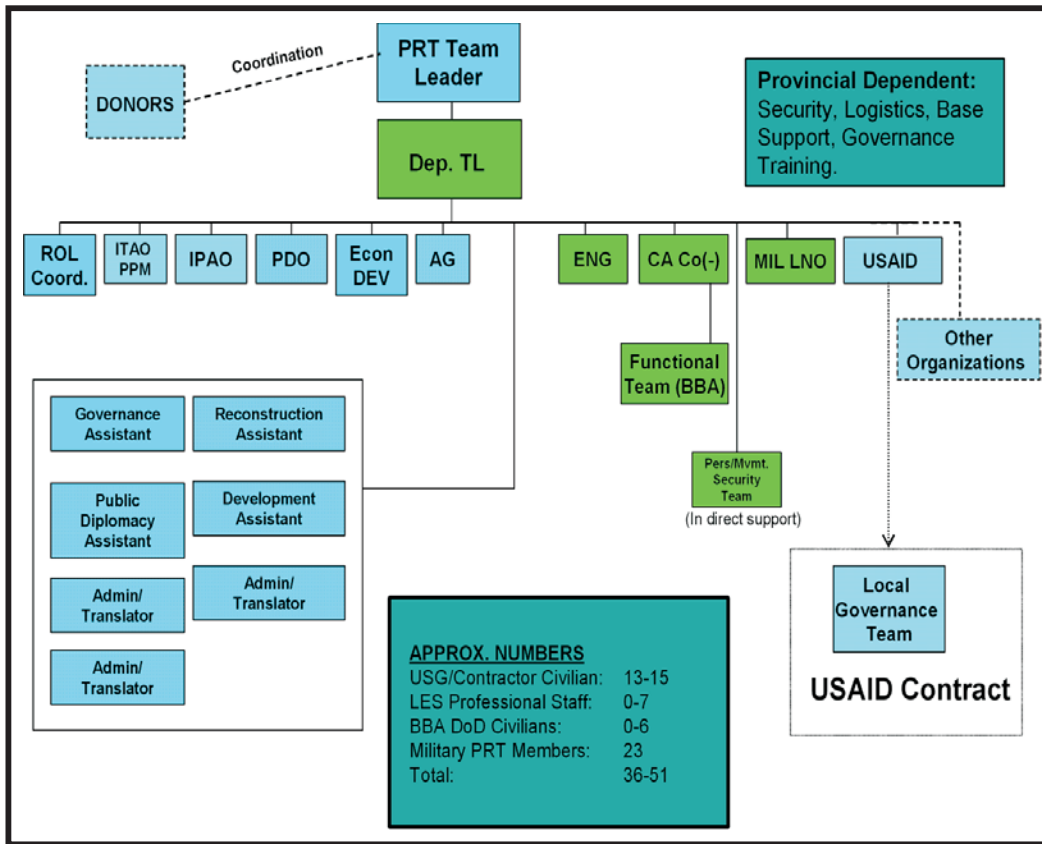

Figure C-3: Nominal PRT organization chart

Note: See “PRT roles and responsibilities” below for definition of abbreviations. This PRT organization chart reflects the functional areas but does not imply that PRTs must task-organize in the same fashion. This chart also reflects a personal security team (also referred to as a military movement team) in direct support of the PRT but does not specify the number of personnel. DOS Cable 4045 specifies between 4 to 20 civil affairs military members; however, in some instances, the smallest unit practicable to deploy in direct support of the PRT is a company.

PRT roles and responsibilities

- **PRT team leader.** The PRT leader is responsible for implementing the DOS-led joint coalition PRT initiative at the provincial level of government. The team leader (TL) is the leader/coordinator of a multiagency, multidisciplinary team comprised of military, civilian, and

locally employed staff. A senior foreign service officer, with leadership experience in a foreign government environment, leads the PRT.

- **Deputy team leader (DTL).** The DTL is the senior military member (O-5 or O-6) of the PRT and is responsible for assisting the TL in implementing DOS's PRT initiative at the provincial level of government. The DTL is the TL's chief of staff and directs the coordination of the multiagency, multidisciplinary team. The DTL, acting as the chief of staff, manages and plans the day-to-day operations and coordinates the scheduling of internal and external events. The DTL is the senior military representative for the MNF-I commander and the approving authority for the security of PRT off-site operations and all convoy operations.
- **Agriculture specialist.** Agriculture consistently has been identified as a key growth area in the provinces. The agriculture specialist may be a USDA specialist and works to enhance the PRT's ability to work with local governments to develop policies and programs that will support this vital economic sector.
- **Bilingual bicultural advisor (BBA).** The BBA program is a DOD contract established to provide professional-level advisors who are expatriate Iraqis with U.S. or coalition citizenship who can help bridge the gap of understanding between USG agencies and their Iraqi counterparts. BBAs possess Bachelor's degrees (or equivalent) or higher and speak fluent English, Arabic, and sometimes Kurdish. They function as a key interface between the PRT members and provincial-level government officials and should be integrated into the PRTs where their backgrounds and education will be of most use.
- **Civil affairs company (CA CO).** The CA CO is responsible for the integration and planning of CA missions in support of the PRT capacity development work plan. As the commander of a unit with military vehicles, the CA CO is responsible for planning and coordinating CA convoy missions with the major subordinate command liaison officer and DTL. The CA CO employs Soldiers and their various skill sets to the best advantage of the PRT; conducts integrated planning with the local governance program (LGP), Iraq Transition Assistance Office, and rule of law efforts; and works in the areas of governance, economics, public works, infrastructure, assessment, metric collection, project inspections, and report writing.
- **Economic development.** This new position serves as the technical lead for economic development and focuses on new programs such as the focused stabilization strategy. This position may be filled with a specialist from any of several civilian U.S. Government (USG) agencies.
- **Engineer officer (ENG).** The ENG trains, coaches, and mentors his Iraqi engineer/reconstruction counterparts on all aspects of project and reconstruction development and management. The ENG ensures that the Provincial Reconstruction Development Council (PRDC) is capable of performing engineering assessments, designing scopes of work, conducting quality assurance and quality control, accomplishing

construction processes, and managing projects. The ENG advises the TL and DTL on the daily situation and changes to reconstruction efforts and activities in the province.

- **Iraqi provincial action officer (IPAO).** The IPAO is responsible for reporting on the provincial atmospherics, including political reporting on the progress toward self-reliance and governance capacity. The IPAO may also report on public affairs. The IPAO, in consultation with the TL, interfaces with local officials and private citizens in support of the PRT public diplomacy work plan to advocate U.S. and chief of mission (COM) policy and collect political information through engagement and observation. The IPAO is responsible for crafting weekly executive summaries and analyzing Iraqi political events and routine political and economic reporting.
- **Iraq Transition Assistance Office provincial program manager (ITAO PPM):** The PPM provides oversight of USG reconstruction efforts and coordinates, liaises, coaches, and mentors PRDC members in all phases of project execution. The ITAO PPM works closely with the PRT ENG.
- **Locally employed staff (LES):** The USAID offices may hire local nationals to support various programs. LES work directly with the local nationals and are used in training provincial council members and their support plan.
- **Military liaison officer (MIL LNO):** The MIL LNO coordinates PRT activities with the local coalition military commander. The LNO coordinates route security, communication, and emergency/contingency planning between PRT and military units. The LNO provides the PRT with provincial security assessments and intelligence alerts completed by the military and passed via secure communications. The LNO is responsible for active battle tracking of all convoy missions from the PRT operations center for the purpose of coordinating with local units.
- **Public diplomacy officer (PDO):** The PDO is a full-time public diplomacy professional dedicated to effectively communicating the good work of the PRT and assisting in developing a public outreach capacity in the provincial government.
- **Rule of law (ROL) coordinator:** The ROL coordinator is responsible for coordinating ROL initiatives at the provincial level, focusing on public law enforcement; a fair civil and criminal judicial system; citizens' equal access to the Iraqi justice system and legal representation; and a humane corrections system, as well as a range of issues that will assist Iraq in transitioning into an effective ROL society. ROL coordinator support to Iraqi governance helps to develop both civil and criminal law and assist police, judicial, and detention institutions by coordinating with Iraqi governmental structures. It also provides support to the civic sector, such as law faculties, lawyer associations, and other rights-based institutions, both governmental and nongovernmental.

- USAID officer:** The USAID officer coordinates USAID efforts with the PRT, LGP, and provincial leaders. The USAID officer synchronizes the LGP through the development of the PRT work plan. The USAID officer trains and coaches members of the PRT on the principles and important points of the LGP and explains the USAID and LGP to the provincial leaders to gain support for training provincial leadership and local government employees. The USAID officer supervises and supports the efforts of LGP employees, identifies staffing requirements tied to the work plan, and recommends the hiring and release of LES. See Appendix 6 of this annex for an explanation of LGP.

Taking into consideration all the various positions, the following diagram provides a suggested team breakout. The sections are intermixed with available personnel resources, both civilian and military.

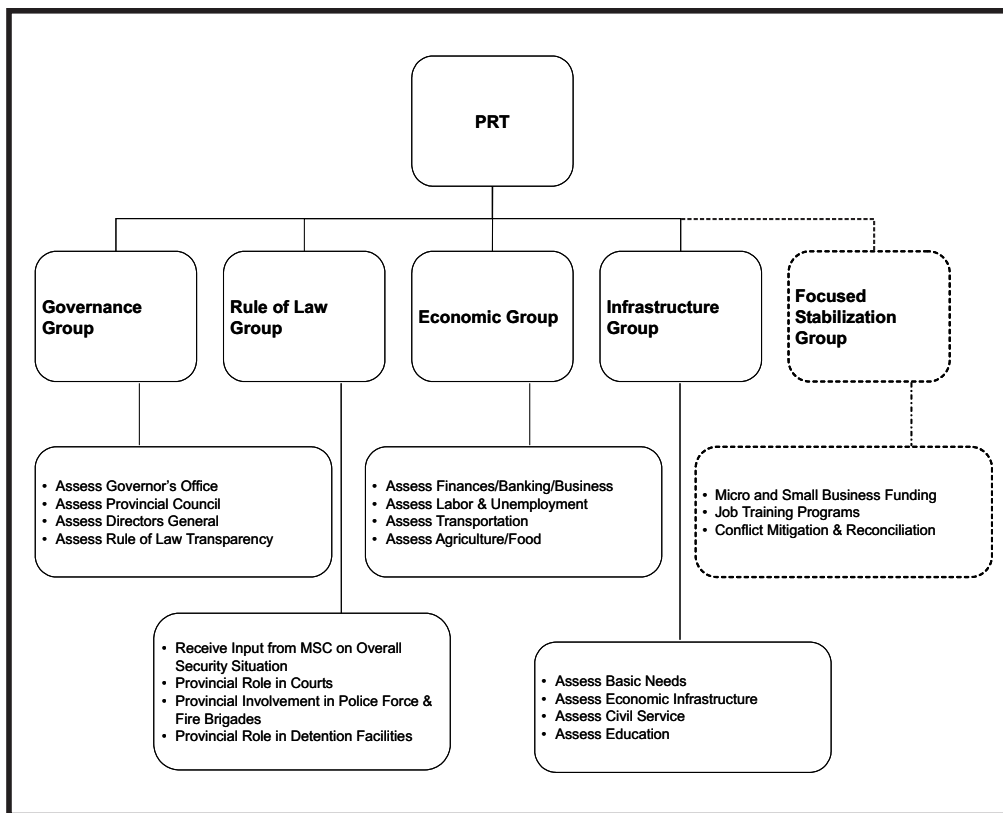

Figure C-4: Suggested PRT breakout flowchart

Embedded PRTs

Embedded provincial reconstruction teams (ePRTs) support BCT/RCT counterinsurgency efforts, empower moderates, foster economic development, and build the capacity of local government and other local institutions in order to hasten the transition to Iraqi self-reliance. The ePRT represents the civilian contribution to the military surge. Their establishment was announced in January 2007 during President Bush’s speech highlighting the USG’s new strategy for Iraq. The roles

and responsibilities of the positions identified in Figure C-4 are the same as stated for nominal PRTs.

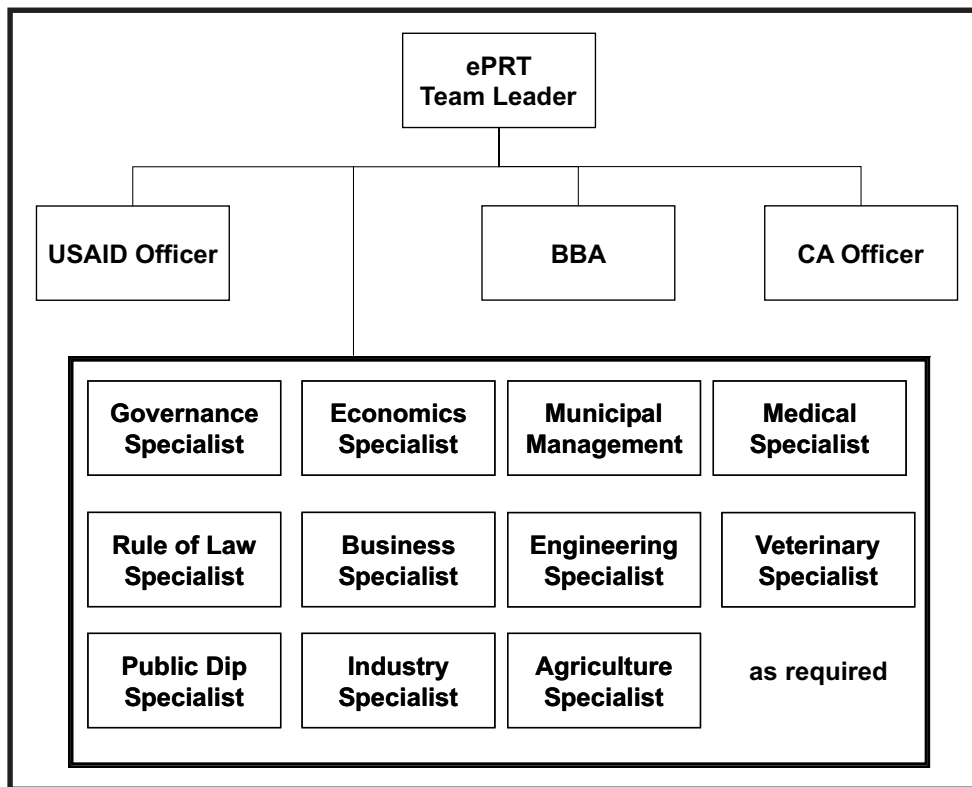

Figure C-5: ePRT organization chart

Provincial Support Team (PST)

For a variety of reasons, the province may not have a PRT; therefore, OPA may deploy only certain elements of a PRT. These elements are referred to as a PST and often are located outside the province. Under this structure, the PSTs receive a dedicated PRT staff, but they execute much of the work through limited engagements (visits to the province and visits to the regional embassy office from provincial leaders) and the use of LES. Although this is a structure that is still evolving, the following elements may be part of a PST:

- PST TL
- IPAO
- ITAO PPM
- ROL coordinator
- USAID coordinator
- LES living and working in the province

Command and Control

According to the 22 February 2007, DOS/DOD Memorandum of Agreement on Iraq PRTs, the COM, through the Office of Provincial Affairs, provides the political and economic direction of PRTs and ePRTs. The BCT/RCT commander “will exercise his authority over security and movement of personnel for PRTs embedded in military units based on security concerns but will not direct members of the PRT as to who they should see, nor deny the members of the PRT the ability to make the contact with certain interlocutors, based on a judgment of priorities other than security.” Their primary mission is to support counterinsurgency operations, focusing on political and economic development, ROL, and reconstruction at the city, district, and neighborhood levels. The ePRT leader has the lead for implementation of political and economic policies and is supported by BCT/RCT. The BCT/RCT commander has the lead for security and movement issues and is supported by the PRT.

Paired PRTs take guidance and direction from the COM conveyed through OPA and coordinate with the local commander at the forward operating base (FOB). They focus on political and economic development, ROL, and reconstruction at the provincial level. The FOB commander has lead for security and movement. Paired PRTs coordinate with embedded PRTs working in their province.

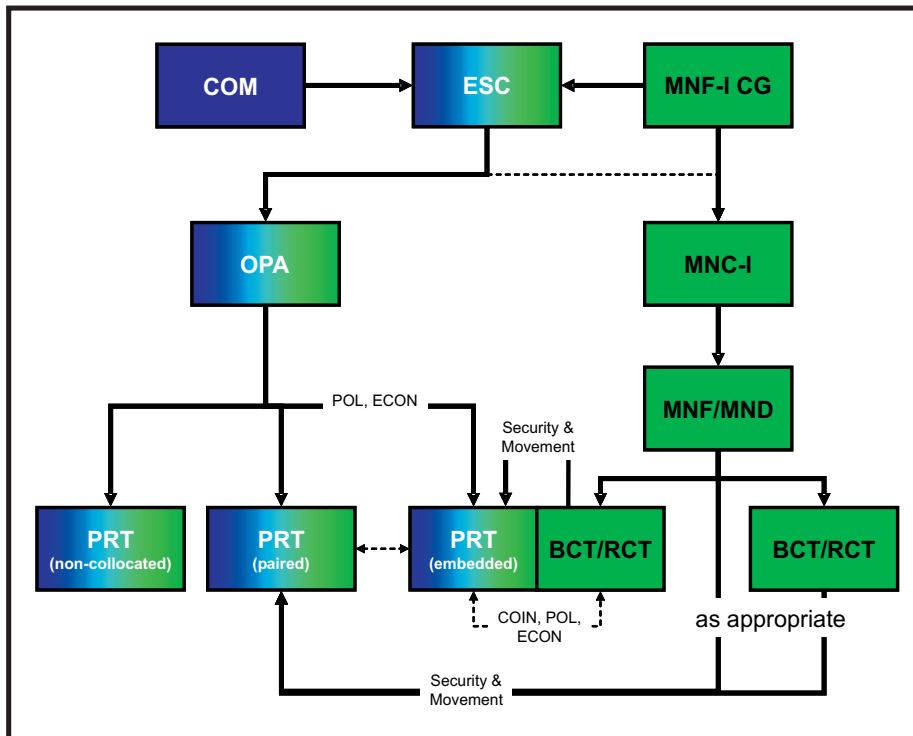

Figure C-6: PRT command structure

Annex C, Appendix 1

**Extract of the Department of Defense/Department of State
Memorandum of Agreement on Iraq PRTs**

1. PURPOSE:

The purpose of this Memorandum of Agreement (MOA) is to specify operational requirements, authorities, and responsibilities shared between the U.S. Mission-Iraq (USM-I) and the Multi-National Forces-Iraq (MNF-I) or successor organizations for Provincial Reconstruction Teams (“PRTs”) in Iraq. The PRT program is a priority joint Department of State (DOS)–Department of Defense (DOD) initiative to bolster moderates, support counterinsurgency strategy, promote reconciliation, and shape the political environment, support economic development, and build the capacity of Iraqi provincial governments to hasten the transition to Iraqi self-sufficiency. Each agency agrees to support the program to the maximum extent provided for in this MOA.

The MOA supplements the agreements and authorities listed under “References” below and does not amend, revise, or change these agreements or authorities except as specified herein.

2. REFERENCES:

- a. Memorandum of Agreement between Department of State and Department of Defense for Support Services in Iraq, dated June 10, 2004.
- b. Memorandum of Agreement between Department of State and Department of Defense Regarding Physical Security, Equipment and Personal Protective Services, dated June 10, 2004.
- c. U.S. Mission Baghdad/MNF-I coordinated cable 4045, dated 010330Z, Oct. 2005, “Action Plan to Build Capacity and Sustainability within Iraq’s Provincial Governments.”
- d. National Security Presidential Directive (NSPD) 36: United States Government Operations in Iraq, dated May 11, 2004.
- e. Memorandum of Agreement (MOA) between Commander, U.S. Central Command, and Chief of Mission, U.S. Mission Iraq Regarding Security Responsibility, dated June 28, 2004.
- f. The Economy Act (31 USC Section 1535).
- g. Title 22, United States Code, Sec. 3927: Chief of Mission Authority.
- h. President’s Letter of Instruction to the United States Ambassador to Iraq.
- i. Supplemental Agreement to the Memorandum of Agreement between Commander, Multinational Force-Iraq, and Chief of Mission, U.S. Mission Iraq Regarding Security Responsibility on PRT Security Responsibilities and Requirements, dated November 9, 2006.

3. GENERAL PROVISIONS:

- a. This MOA covers all PRTs, including Regional Reconstruction Teams (RRTs), Provincial Support Teams (PSTs), and embedded PRTs, all of which are hereafter referred to collectively as PRTs, existing or to be established in Iraq.
- b. This MOA is not intended to identify each and every support requirement or to prejudice the ability of the Chief of Mission (COM) or Commander, MNF-I to make requests for support not specifically stated herein. Rather, this MOA is intended to address the majority of support issues and to provide baseline direction for support responsibilities. Except in emergency circumstances, requests for additional support beyond that provided for herein will take the form of a written request from the COM to the Commander, MNF-I or from the Commander, MNF-I to the COM, as specific circumstances dictate. Such requests may be for reimbursable or non-reimbursable support.
- c. This MOA will be implemented consistent with available funding and applicable law. The parties' ability, as a practical matter, to implement this MOA depends on their ability to obtain adequate supplemental funding for this purpose.

4. AREAS OF AGREEMENT:

- a. Authority:
 - (i) PRTs are a joint Department of State–Department of Defense mission, and they operate under joint policy guidance from the COM and Commander, MNF-I, harnessing both civilian and military resources against a common strategic plan. The PRT/BCT will function as one team. Together they will receive guidance from both COM and Commander, MNF-I that will follow a common plan for their joint AOR.
 - (ii) The Department of State will lead PRTs and is responsible for recruiting, hiring, and managing civilian PRT personnel.
 - (iii) Embedded PRTs will also coordinate their activities with the paired PRT in their area (e.g., the existing Baghdad and Anbar PRTs, which will maintain primary responsibility for provincial-level engagement). The COM and Commander, MNF-I will jointly decide whether PRTs are considered to be paired with or embedded in military units for purposes of this memorandum.
 - (iv) The COM provides political and economic guidance and direction to all PRTs. The BCT Commander will exercise his authority over security and movement of personnel for PRTs embedded in military units based on security concerns but will not direct members of the PRT as to who they should see, nor deny the members of the PRT the ability to make contact with certain interlocutors, based on a judgment of priorities other than security.

(v) All parties will coordinate closely in the development of relevant guidance on PRT activities, not only to deconflict relevant activities, but more importantly so that all activities work together toward the common goal of bolstering moderates, supporting U.S. counterinsurgency strategy, and strengthening the capacity of provincial governments to accelerate the transition to Iraqi self-reliance.

(vi) Any disputes between BCT Commanders or other military commanders and PRT leaders concerning the policies, procedures, or activities of PRTs will be submitted promptly to the COM and Commander, MNF-I or their senior representatives for resolution.

(vii) All military personnel providing support to PRTs will fall under the UCMJ authority of their respective chains of command as determined by the appropriate command relationships.

b. Performance Reporting:

(I) PRT Team Leaders are responsible for the overall performance of their joint civil-military team and will monitor the individual performance of all members of their team. Evaluation reports will be prepared in accordance with Mission policy and employing agency

(ii) MNF-I units provided in direct support to the PRT will follow their internal raring chain. DOD and Military Department Service regulations and procedures will be followed.

c. Regulations and Policies:

(I) PRTs will observe COM directions, rules, policies and procedures, to the extent applicable. In relation to matters of security for which Commander, MNF-I is responsible, PRT members will comply with MNF-I safety and force-protection measures as provided in Reference 2(i) above.

(ii) Each PRT member who is a Federal employee remains an employee of his or her department or agency and subject to the regulations, policies, and procedures of that department or agency to the extent not inconsistent with COM or Commander, MNF-I requirements. Military personnel shall continue to observe MNF-I regulations in their personal and professional conduct in support of the PRT mission.

(iii) Each PRT member who is made available through an institutional contractor will be responsible for performing his/her PRT duties in accordance with the statement of duties prescribed in the contract and shall be subject to the general guidance of the department or agency that awarded the contract, to the extent not inconsistent with COM or Commander, MNF-I requirements. Further, any conflict between the terms and conditions of the contract under which institutional contractors are employed, their specific agreement with their employer, and COM rules, policies,

and procedures should be resolved prior to their assignment to a PRT.

d. Concept of Support:

(I) PRTs are critical elements in achieving the goals of the USG in Iraq. As such, they will be provided the highest level of support available, and the support PRT members receive will be without distinction based on their home organizations, or whether they are USG employees, contractor personnel, or foreign nationals, except as otherwise provide herein or by separate agreement or contract.

(ii) DOS will be responsible for providing, or reimbursing DOD for all operational support and life support for PRTs, consistent with sections e and f of this MOA. "Operational support" means necessary facilities and facilities services (e.g., office space, office supplies, and related equipment and services), logistic and infrastructure support (e.g., facilities upkeep and management), and basic utilities/services (e.g., power water, sewer, fire protection, drainage, waste management, hazardous material management, and environmental services). "Life support" includes lodging, food, water, bath and sanitation, and any morale, recreation and welfare facilities or services (e.g. laundry services, food service operations, postal operations, check cashing, and Army & Air Force Exchange Service (AAFES) mail order service).

(iii) DOD will be responsible for providing on a non-reimbursable basis all in-theater air and ground transportation and associated support to PRTs, consistent with the terms of Annex A of this MOA.

(iv) DOD will be responsible for providing all medical support including necessary primary care, to PRTs collocated with US military units, as well as medical evacuation and mortuary services as required for PRT personnel regardless of locations. PRT contractors and foreign government personnel will be provided medical support, medical evacuation and mortuary services in accordance with the terms of applicable contract provisions or agreements. DOS or the relevant contracting agency, as appropriate, will reimburse DOD for medical support, medical evacuation, and mortuary services provided to PRT members. DOS will be responsible for any arrangements for PRT primary medical care at non-collocated PRTs and for primary care for civilian PRT members in the International Zone.

(v) Communications and information systems support to non-collocated and paired PRTs shall be provided to PRTs consistent with the terms of Annex B of this MOA. At embedded PRTs, DOD will provide communications and information support, and DOS will reimburse.

(vi) For PRTs located on Mission facilities or on Non-U.S. Coalition facilities, the COM or his designee will have overall decision authority on the PRT location. For PRTs collocated with U.S. military units, the responsible Major Subordinate Command will

have overall decision authority on the PRT location, facilities management, and administrative and logistic support. The COM and the Commander, MNF-I, or their designees, will coordinate regarding PRT locations.

(vii) DOS and DOD will finalize reimbursement procedures for life and operational support within 30 days of signature of this MOA.

(viii) If factors arise that affect the continued maintenance of a PRT at a specific location, its status, or the provision of support, the Commander, MNF-I and the COM, or their designated representatives, will consult with each other and with their respective chains of command so that appropriate alternative arrangements can be made.

(ix) To facilitate PRT operations, PRT members will be issued appropriate facility access badges in accordance with the applicable security policies. PRT members will hold an appropriate security clearance, background investigation, or employment verification check based on the requirements of the assigned position. Verification will be established through security channels.

e. Support Levels and Funding for PRTs Collocated with U.S. Military Units:

(I) DOD will provide operational and life support for PRTs collocated with BCTs or other U.S. military units, regardless of whether such support is organic to the military unit except as provided in subparagraph (v) below. DOS will reimburse DOD for such support.

(ii) DOD will provide all support specified in this MOA for PRTs collocated with BCTs or other U.S. military units at the levels provided to MNF-I personnel of similar grade at similar locations.

(iii) DOD will provide operational and life support for PRT contractor personnel serving on PRTs collocated with U.S. military units on a reimbursable basis. In the case of a DOD contractor, DOS will reimburse DOD for the cost of such support. In all other cases, the contracting agency will reimburse DOD for the cost of such support.

(iv) Foreign government personnel assigned to PRTs will be provided the same level of support as other PRT members, subject to the terms of funding arrangements as agreed in the particular case in view of the mission of such personnel and any governing agreement with their respective countries.

(v) DOD is responsible for funding repair and maintenance of all DOD equipment and vehicles, and DOS is responsible for funding repair and maintenance of all DOS equipment and vehicles. All maintenance support provided by DOD for DOS equipment and vehicles will be reimbursed by DOS.

f. Support Levels and Funding for PRTs Not Collocated with U.S. Military Units:

(I) DOS will provide operational and life support for PRTs not collocated with U.S. military units on a non-reimbursable basis, except as provided in subparagraph (v) below, unless arrangements are made for DOD to provide such support on a reimbursable basis, or unless a coalition partner agrees to provide such support.

(ii) DOS will provide any support for PRTs not collocated with U.S. military units at the levels provided to DOS personnel of similar grade.

(iii) Except where the contract provides that the government will provide support, arrangements will be made for contractors serving on PRTs not collocated with U.S. military units to reimburse the non-DOD service provider directly (i.e., DOS or Coalition partner as applicable) for the operational and life support they receive. Where the contract provides that the government will provide support, the contracting agency will reimburse the non-DOD service provider for the cost of such support.

(iv) In cases where DOD provides operational and life support for PRT contractor personnel serving on PRTs not collocated with U.S. military units, such support will be provided on a reimbursable basis. In the case of a DOD contractor, DOS will reimburse DOD for such support. In all other cases, the contracting agency will reimburse DOD for the cost of such support.

(v) Foreign government personnel who are PRT members will be provided support on the same basis as other PRT members, with funding arrangements as agreed in the particular case in view of the mission of such personnel and any governing agreement with their respective countries.

(vi) DOS is responsible for funding repair and maintenance of all DOS equipment and vehicles. All maintenance support provided by DOS for DOD equipment and vehicles will be reimbursed by DOD.

g. Transitional Agreements:

(I) DOD will pay salary costs for the initial DOD staffing for the PRT surge, anticipated to include 129 positions for a period not to exceed 12 months. DOS will fund all non-DOD agency salary costs for PRT positions thereafter, to the extent that funds are made available to DOS specifically for this purpose.

(ii) DOS will initiate measures to identify replacement personnel for the 109 specialist positions DOD will fill during Phase II. Where advantageous for achieving the PRT mission, DOS will be prepared to replace all of these DOD-provided specialist personnel no later than 90 days after receiving funding for that purpose. In any event, DOS will be prepared to replace these DOD-provided specialist personnel within 12 months of their deployment.

5. ANNEXES:

The following Annexes are included and made part of this MOA:

- A. Air and Ground Transportation Support
- B. Communications and Information System Support
- C. Appendix 1: Communications Support Matrix
- D. PRT Matrix [removed]

6. EFFECTIVE DATE, MODIFICATION AND TERMINATION:

This Memorandum of Agreement will become effective upon signature by both Parties. PRT support extended prior to signature of this MOA will be inclusive. MNF-I and U.S. Mission-Iraq will review this MOA annually for currency and applicability. This MOA may be amended in writing as mutually agreed by the Parties.

Original signed

**Extract of the Department of Defense/Department of State
Memorandum of Agreement on Iraq PRTs**

ANNEX A

AIR AND GROUND TRANSPORTATION SUPPORT

1. Type of Support Being Provided

- a. In light of DOD's mission to provide security for U.S. government personnel serving in Iraq, the joint PRT mission, and the current circumstances within Iraq creating an inseparable connection between security and transportation for PRTs, DOD will provide transportation support to PRTs on a non-reimbursable basis.
- b. Type of support provided to PRTs is the same as stated in Annex D of reference 2.a. except as modified below regarding PRTs.
- c. In addition to those stated in reference 2.a., Annex D section 2, Coalition members assigned to PRTs may be support recipients. Such Coalition members may be provided transportation as provided herein on a non-reimbursable basis where there is no additional cost to DOD. In circumstances where there will clearly be an additional cost to DOD, such transportation may be provided on a reimbursable basis under arrangement to be worked out on a country-by-country basis.

2. Air Movement of PRTs

- a. Military air support provided in theater to the PRTs will be provided in accordance with reference 2.a and existing Fragmentary Orders (FRAGOs).
- b. Local Rotary Wing (RW) Support. PRTs will normally submit RW air mission requests (AMRs) to the Major Subordinate Command (MSC) G-3 Aviation in whose area of responsibility the PRT resides, which will consider them as priority requests. For RW movements that extend beyond that MSC's area of responsibility, MNF-I will establish procedures for integrating such movements across other MSCs, including using MNC-I general support (GS) airlift (including scheduled ring routes) when appropriate. PRT rotary wing support requirements will be prepared and submitted in accordance with established MNF-I, MNC-I, and MSC timelines and procedures.
- c. MNF-I in coordination with the U.S. Mission-Iraq, will monitor changes to RW movement patterns generated by PRT airlift requirements and may adjust or establish new scheduled flight routes to optimize the use of its GS and MSC-assigned RW fleets to best meet MNF-I customer base needs most effectively.
- d. Integrated Fixed Wing (FW) Air Movement Support. PRTs will submit airlift support requirements for FW support to the U.S. Embassy-Baghdad Joint Area Support Group-Transportation (JASG-T), a subordinate unit of MNF-I, which will consider them as priority requests. The JASG-T will forward these FW airlift requirements using the Intra-Theater Airlift

Request System (ITARS). The JASG-T will also coordinate for FW support to accomplish relief-in-place operations and the FW transport of goods, programs, supplies, and services. FW support requirements will be prepared and submitted in accordance with USCENTCOM/USCENTAF AMD timelines and procedures.

e. Chief of Mission (COM) Airlift Assets. DOS dedicated RW assets will be used as a means of PRT personnel movement when available. These RW assets are only available between Baghdad and Hillah.

f. The Commander, MNF-I and the COM will address the priority to be accorded PRT air support requests in the joint guidance cited in paragraph 4.a.(i). of the MOA.

3. Ground Movements of PRTs

a. The commander of the relevant military unit is responsible for providing all ground movement for the PRTs that are collocated with U.S. military units. Readily available ground movement capability is critical to the success of the PRT mission, and the military commander will make every effort to accommodate requests by PRT learn leaders for such transportation.

b. Recognizing that the need for PRT ground movement assets is dependent upon a range of factors (e.g., size of the PRT, specifics of the common plan, geography of the AOR, etc.), and that the availability of ground movement assets is similarly dependent (e.g., combat situation, maintenance considerations, etc.), the BCT will make convoys available in accordance with existing agreements, absent compelling circumstances that preclude doing so.

c. The PRT leader will submit a prioritized list of movement requests for ground transportation assets at least 48 hours in advance of the travel.

d. Convoy requirements are specified in reference 2.j. of the MOA.

**Extract of the Department of Defense/Department of State
Memorandum of Agreement on Iraq PRTs**

ANNEX B

COMMUNICATIONS AND INFORMATION SYSTEMS SUPPORT

1. Concept of Support

This annex outlines roles, responsibilities, functions, and lines of authority for communications and information systems support of the PRTs. PRTs will require communications systems to include: automation and information processing, telephones, and radios. Information operating systems and software must be compatible and establish commonality, regardless of supporting activity, to the greatest extent feasible. The National Coordination Team (NCT) will appoint a member responsible for PRT communications oversight to achieve this objective.

2. PRTs Communications and Information Systems Capabilities

The communications and information capabilities outlined in Appendix 1 to this annex represent capabilities PRTs may require in various capacities to perform their missions. PRT team leaders will determine what capabilities are essential to the mission of their specific PRT, and identify requirements for network access, number of telephones, computers, radios, etc. These requirements will be coordinated with the NCT and forwarded to DOS Information Management Office (IMO) Iraq (for non-collocated PRTs) or MNF-I Chief of Information S (for collocated PRTs), as appropriate. Level of fulfillment of those requirements will be dependent on availability of assets and on-site support. The SCT functions as the node of operations and communications center for PRT communications; and will establish and enforce standards and procedures for interoperability. The NCT will consult DOS/IMO Iraq and MNF-I CIS regarding communications management.

3. Concept of Information Support

a. Roles and responsibilities: DOS/IMO Iraq and MNF-I CIS are responsible for providing communications and information systems support to non-collocated PRTs and collocated PRTs, respectively, consistent with standing orders and regulations, and in accordance with this MOA.

b. Policy: DOS and DOD regulations, procedures, and policies pertaining to communications and information systems support will retain their inherent authority in their respective systems. This MOA does not abrogate, supersede, or invalidate standing regulations, policies, or procedures that are intended to ensure the inherent security of the systems.

c. Network Services: Requests for network services support will be directed through NCT to MNF-I CIS or DOS/-IMO Iraq, as appropriate. Network Services will include, at the component level, base-lining of computer systems, internet connectivity, Help Desk support, trouble shooting, and repair and replacement. IT specialists at either collocated or non-collocated sites will not be required to provide unique or special equipment nor normally available. DOS/-IMO Iraq and MNF-I CIS are responsible for the security of their respective networks and will retain the authority to manage

network services consistent with organizational regulations, policies, and procedures.

d. Network Access: In cases where the PRT is not collocated with a U.S. military unit solely supported by a Regional Embassy Office (REO), DOS/ IMO Iraq will provide appropriately cleared personnel with access to both ClassNet and OpenNet systems. Where a PRT is collocated with a U.S. military unit, MNF-I will provide appropriately cleared personnel with access to both SIPRnet and NIPRnet. A minimum of 1 SIPR line per every 3 PRT members with appropriate security clearance and 1 NIPR line per PRT member with authorized access are required per collocated PRT. DOS/ IMO Iraq will provide additional access for the PRT to an unclassified network and commercial telephones via a commercial satellite system. USG IT contractors with a Secret or higher security clearance will be provided network access to the extent permitted by DOD/DOS regulations, but will include—at a minimum—administrative rights on any commercial systems.

e. Terminal Equipment: The PRT leader is responsible for identifying numbers of equipment each team will require (telephones, radios, computers, monitors, printers, etc.). Requests will be made through the NCT to either DOS/ IMO Iraq (for non-collocated PRTs) or MNF-I CIS (for collocated PRTs), as appropriate.

f. Maintenance of ADPE and Radio Equipment: DOS/ IMO Iraq will maintain DOS-provided equipment. MNF-I will maintain DOD-provided equipment.

g. Voice Communications:

1) Telephones: Telephone service will be provided to the PRT through the existing telephone capacity of the supporting activity (non-collocated/collocated REO/FOB/other facility). Telephone services provided by MNF-I normally include only the DSN line, and not the telephone instrument. MNF-I will provide SVOIP, SIPRNET, and VOIP telephones from NIPRNET. DOS/ IMO will provide unclassified telephones via a commercial satellite system. Telephone service will provide, at a minimum, internal communications; access to the U.S. Embassy, Baghdad, Iraq; access to Headquarters MNF-I and MNC-I; and access to U.S. commercial telephone numbers.

2) Mobile telephones: Where possible, cellular telephones may be a significant enhancement to the PRT communications plan and may even supplant land-line telephone communications. There is no single nationwide cellular service provider in Iraq; therefore, mobile telephone support must be based on area of operation. In instances where the supporting activity has an established account or relationship with local service providers, the activity will extend those services to the PRT.

3) Satellite telephone: DOS/ IMO Iraq will provide two satellite telephones and service per PRT. These telephones will be assigned to PRT Team Leaders and Deputy Team Leaders for use by PRT

members, as appropriate. PRT Team Leaders will be responsible and accountable for satellite telephone usage.

h. Frequency Management: MNF-I CIS is responsible for frequency allocation and management for military band UHF and HF. DOS IMO Iraq will coordinate frequency management and allocation for DOS unique frequency requirements through MNF- I CIS.

i. Communications Operations: PRTs will manage internal team communications. The team leader will establish liaison with the supporting site for integration and coordination of PRT Emergency and Evacuation (E&E) communications with existing force protection procedures.

j. COMSEC Operations: As appropriate, DOS/DOD will provide COMSEC for systems at each location. All USG COMSEC regulations, policies, and procedures will apply to PRT operations.

k. Military Movement Teams: Military movement teams used to transport PRT personnel will provide their own communications for both movement and site/venue security.

**Extract of the Department of Defense/Department of State
Memorandum of Agreement on Iraq PRTs**

Appendix 1

**Communications and Information Systems Arrangements
in Place for Current PRTs**

Functional Area	Provider	Non-Collocated PRT	Paired PRT	Remarks
Unclassified				
Data*				
OpenNet	DOS	X		DOS will provide Help Desk support.
NIPR	DOD		X	Minimum of 1 per PRT member. DOD will provide Help Desk support.
Classified				
Data*				
ClassNet	DOS	X		DOS will provide Help Desk support.
SIPR	DOD		X	Minimum of 1 line per every 3 cleared PRT members. DOD will provide Help Desk support.
Commercial Internet/Data	DOS	X	X	Minimum of 50 users. DOS contractors will provide Help Desk support. This service must also provide 30 commercial VoIP phones as well.
Unclassified Voice				

CENTER FOR ARMY LESSONS LEARNED

Functional Area	Provider	Non-Collocated PRT	Paired PRT	Remarks
IVG/VoIP	DOS	X		
DSN/VoIP	DOD		X	
Satellite Phone	DOS	X		
USG GSM	DOS	X		Coverage is limited to Baghdad.
Commercial Iraqi Cell Phone	DOS DOD	X	X	Dependent on commercial carrier availability.
Classified Voice				
SVoIP	DOD		X	
Data Sharing Capability				Need to determine hosting organization and parameters.
GRD/PCO Database	DOD	X	X	GRD/PCO is integrator.
Radio	DOS DOD	X	X	Radio nets will be determined by hosting organization. Cross-compatibility can be realized via the technical integrator.
Radio Equipment	DOS	X		Needs determined individually per PRT site.
VTC	DOD DOS	X	X	Bandwidth and requirement dependent.

PROVINCIAL RECONSTRUCTION TEAM PLAYBOOK

Functional Area	Provider	Non-Collocated PRT	Paired PRT	Remarks
COMSEC	DOD DOS	X	X	COMSEC accounts are not available at some sites; compatibility requirements may require military support.
<p>*Note: This matrix indicates capabilities suggested for PRTs and commonly available means to achieve them. The actual means by which these capabilities are realized will vary from site to site. PRTs will inform NCT of local solutions and will request support when capability shortfalls exist. Data services include basic functionality and support including, but not limited to: transmission path; Help Desk support; limited ADPE repair and maintenance; and workstation administration. Application administration will be supported to the best abilities of the supporting agency (DOS or DOD). Network security requirements will remain as required by the respective supporting agency.</p>				

Annex C, Appendix 2
Iraq Background Notes

Official Name: Republic of Iraq

Geography:

- Area: 437,072 sq km (168,754 sq mi)—slightly more than twice the size of Idaho.
- Cities (2005 est.): Capital – Baghdad (6,956,562); other cities – Mosul (1,174,022), Basrah (1,100,790), Irbil (910,381), Kirkuk (618,149).
- Terrain: mostly broad plains; reedy marshes along Iranian border in south with large flooded areas; mountains along borders with Iran and Turkey.
- Climate: mostly desert; mild to cool winters with dry, hot, cloudless summers; northern mountainous regions along Iranian and Turkish borders experience cold winters with occasionally heavy snows that melt in early spring, sometimes causing extensive flooding in central and southern Iraq.

Government:

- Type: Parliamentary democracy.
- Independence: 3 October 1932.
- Constitution: 15 October 2005.
- Branches: Executive – president (chief of state), prime minister (head of government); Legislative – bicameral Council of Representatives (275 seats) and a Federation Council (membership not established and authorities undefined); Judicial – Higher Juridical Council, Supreme Federal Court, Federal Court of Cassation, Public Prosecution Department, Judiciary Oversight Commission, and other federal courts.
- Political subdivisions: 18 provinces.
- Suffrage: Universal at 18 years.

Economy:

- GDP (2006 est.): \$40.66 billion.
- GDP growth (2006 est.): 2.4%.
- GDP per capita (2006 est.): \$2900.
- Natural resources: petroleum, natural gas, phosphates, sulfur.

- Agriculture (estimated 7% of GDP): Products – wheat, barley, rice, vegetables, dates, cotton, cattle, sheep, poultry.
- Industry (estimated 67% of GDP): Types— petroleum, chemicals, textiles, leather, construction materials, food processing, fertilizer, metal fabrication/processing.
- Services (estimated 26% of GDP): Transport, retail, and telecommunications.
- Trade (2005-06 est.):
 - Exports – \$32.19 billion: crude oil 84%, crude materials excluding fuels 8%, food and live animals 5%; Major markets – U.S., Europe, Canada.
 - Imports – \$20.76 billion: food, medicine, manufacturers; Major suppliers – Middle East countries, U.S.
- Currency: The currency is the New Iraqi *dinar* (NID) as of 22 January 2004. As of 17 July 2007, \$1 U.S. equals approximately 1,250 dinar.

People:

- Nationality: Noun and adjective – Iraqi(s).
- Population: 27,499,638 (July 2007 est.). Approximately two million Iraqis have fled the conflict in Iraq, with the majority taking refuge in Syria and Jordan and lesser numbers to Egypt, Lebanon, Iran, and Turkey.
- Annual population growth rate (2007 est.): 2.618%.
- Main ethnic groups: Arab 75%-80%, Kurdish 15%-20%, Turkoman, Assyrian, or other 5%.
- Religions: Muslim 97% (Shi'a 60%-65%, Sunni 32%-37%), Christian, or other 3%.
- Main languages: Arabic, Kurdish (official in Kurdish regions), Assyrian, Armenian.
- Education: Literacy (2000 est.) – 74.1% (male 84.1%, female 64.2%).
- Health: Infant mortality rate (2007 est.) – 47.04 deaths/1,000 live births; Life expectancy (2007 est.) – 68.04 yrs. (male), 70.65 yrs. (female).

Historical information: Formerly part of the Ottoman Empire, Iraq was occupied by Britain during the course of World War I. In 1920, it was declared a League of Nations mandate under U.K. administration. In stages over the next dozen years, Iraq attained its independence as a kingdom in 1932. A “republic” was proclaimed in 1958, but in actuality a series of military strongmen ruled the country until 2003;

the last was Saddam Hussein. Territorial disputes with Iran led to an inconclusive and costly eight-year war (1980-88).

In August 1990, Iraq seized Kuwait, but was expelled by U.S.-led, United Nations (UN) coalition forces during the Gulf War of January–February 1991. Following Kuwait's liberation, the United Nations Security Council (UNSC) required Iraq to scrap all weapons of mass destruction and long-range missiles and to allow UN verification inspections. Continued Iraqi noncompliance with UNSC resolutions over a period of 12 years led to the U.S.-led invasion of Iraq in March 2003 and the ouster of the Saddam Hussein regime. Coalition forces remain in Iraq under a UNSC mandate, helping to provide security and to support the freely elected government.

The Coalition Provisional Authority, which temporarily administered Iraq after the invasion, transferred full governmental authority on 28 June 2004 to the Iraqi Interim Government, which governed under the Transitional Administrative Law for Iraq (TAL). Under the TAL, elections for a 275-member Transitional National Assembly (TNA) were held in Iraq on 30 January 2005. Following these elections, the Iraqi Transitional Government (ITG) assumed office. The TNA was charged with drafting Iraq's permanent constitution, which was approved in a 15 October 2005 constitutional referendum. An election under the constitution for a 275-member Council of Representatives (CoR) was held on 15 December 2005. The CoR approval in the selection of most of the cabinet ministers on 20 May 2006 marked the transition from the ITG to Iraq's first constitutional government in nearly a half-century.

Annex C, Appendix 3

United Nations Assistance Mission for Iraq

The United Nations Assistance Mission for Iraq (UNAMI) was heralded in Security Council Resolution 1500, adopted on 14 August 2003, as a one-year follow-through mission in the wake of the Oil-for-Food program handover on 21 November 2003.

In the aftermath of direct attacks on the United Nations (UN) in Iraq and the subsequent evacuation of the UN international staff from Baghdad by November, political and security concerns *vis a vie* mandate and re-entry were urgently reviewed by the Secretary General. During this period, a core UNAMI forward planning team supported the development of innovative operational options for continued UN involvement in Iraq and established a centralized coordination and information sharing mechanism for the relocated humanitarian community in Amman.

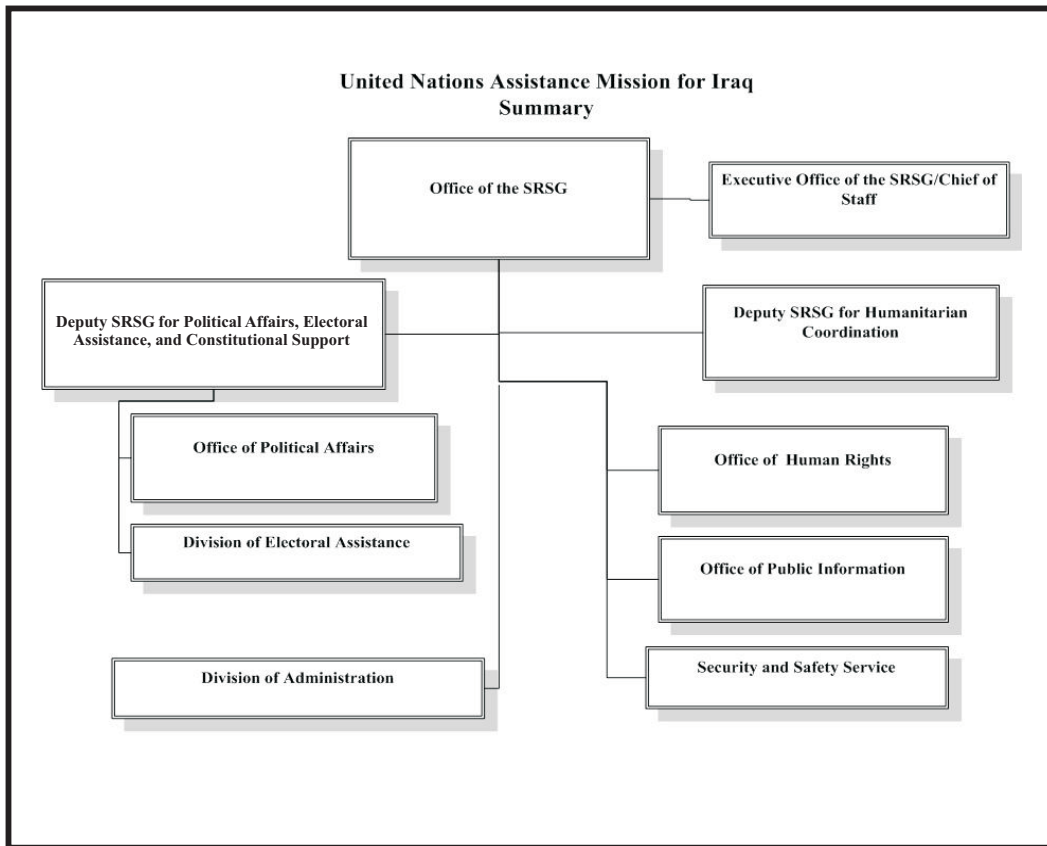

Figure C-7: Organizational chart

Mandate

In accordance with Security Council Resolution 1546, the mandate of UNAMI is as follows:

... in implementing, as circumstances permit, their mandate to assist the Iraqi people and government, the Special Representative of the Secretary-General and the United Nations Assistance Mission for Iraq (UNAMI), as requested by the Government of Iraq, shall:

- Play a leading role to:
 - Assist in the convening, during the month of July 2004, of a national conference to select a Consultative Council
 - Advise and support the Independent Electoral Commission of Iraq, as well as the Interim Government of Iraq and the Transitional National Assembly, on the process for holding elections
 - Promote national dialogue and consensus-building on the drafting of a national constitution by the people of Iraq
 - Advise the Government of Iraq in the development of effective civil and social services
 - Contribute to the coordination and delivery of reconstruction, development, and humanitarian assistance
 - Promote the protection of human rights, national reconciliation, and judicial and legal reform in order to strengthen the rule of law in Iraq
 - Advise and assist the Government of Iraq on initial planning for the eventual conduct of a comprehensive census.

UN Country Team

The UN Country Team, a family of UN organizations involved in Iraq, consists of 16 UN agencies and programs, coordinated by UNAMI.

UN agencies, funds, programs, and offices:

- Economic and Social Commission for Western Asia
- Food and Agriculture Organization
- International Labor Organization
- Office of the UN High Commissioner for Human Rights
- United Nations Development Program
- United Nations Environment Program
- United Nations Education, Science, and Cultural Organization
- United Nations Population Fund
- United Nations Center for Human Settlements
- United Nations High Commissioner for Refugees
- United Nations Children’s Fund
- United Nations Industrial Development Organization
- United Nations Fund for Advancement of Women
- United Nations Office for Project Services
- World Food Program
- World Health Organization

Affiliated bodies:

- International Organization on Migration
- World Bank

UN Security Council Resolutions (UNSCRs)

UNSCR 1483 (22 May 2003): Lifts nonmilitary sanctions. It also recognizes Britain and the United States as occupying powers (‘The Authority’) and calls on them to attempt to improve security and stability and provide opportunities for Iraqis to determine their political future. It creates the position of ‘UN Special Representative to Iraq’ to coordinate UN activity, and requires the establishment of the Development Fund for Iraq.

UNSCR 1500 (14 Aug 2003): Welcomes the creation of a governing council and establishes a UN Assistance Mission for Iraq, as proposed by the Secretary General in a report on July 17. (Extended by UNSCR 1557, 12 Aug 2004; 1619, 11 Aug 2005; 1700, 10 Aug 2006).

UNSCR 1511 (16 Oct 2003): This resolution mandates the UN to ‘strengthen its vital role in Iraq’ and ‘underscores . . . the temporary nature of the Coalition Provisional Authority.’ Supporting moves towards self-government under its auspices, it invites the Governing Council to draw up, by 15 December, a timetable for drafting a constitution and holding elections, and requests the CPA to report to the Security Council on progress towards the transfer of power. A multinational security force is authorized. States are urged to contribute financially by providing required resources and by transferring assets of the former regime to the Development Fund for Iraq. It also requests the Secretary General to report on UN operations in Iraq; requests the US to report, at least every 6 months, on military matters; decides that the Security Council should review the mission of the UN force within a year; and states that its mandate will expire once power has been transferred to an Iraqi government.

UNSCR Resolution 1546 (08 June 2004): Endorses the formation of the interim government, welcomes the end of the occupation, and anticipates the prospect of elections in January 2005. It also reaffirms the authorization for the multinational force under unified command established under resolution 1511 (2003) and decides that the multinational force shall have the authority to take all necessary measures to contribute to the maintenance of security and stability in Iraq in accordance with the Iraqi request for the continued presence of the multinational force.

UNSCR 1637 (08 Nov 2005): Extends the mandate of the multinational force in Iraq until December 2006, though it includes the proviso that the Iraqi government should review this mandate no later than the 15th of June 2006. It also extends current arrangements for the depositing into the Development Fund for Iraq of proceeds from export sales of petroleum, petroleum products, and natural gas until December 2006, also to be reviewed by the Iraq government no later than the 15th of June 2006.

UNSCR Resolution 1723 (28 Nov 2006): Extends the mandate of the international force in Iraq until the end of 2007, using language essentially identical to that of the previous year’s resolution 1637.

Annex C, Appendix 4

NATO's Assistance to Iraq

While the North Atlantic Treaty Organization (NATO) does not have a direct role in the international stabilization force that has been in Iraq since May 2003, the alliance is helping Iraq provide for its own security by training Iraqi military personnel, supporting the development of the country's security institutions, and coordinating the delivery of equipment. All NATO member countries are contributing to the training effort either in or outside Iraq, through financial contributions or donations of equipment.

Aim of the Operation

NATO is involved in training, equipping, and technical assistance—not combat. The aim is to help Iraq build the capability of its government to address the security needs of the Iraqi people.

Policy Evolution

At their summit meeting in Istanbul on 28 June 2004, NATO heads of state and government agreed to assist Iraq with training its security forces. A training implementation mission was established on 30 July.

In a letter sent to the NATO Secretary General on 22 June 2004, the interim Iraqi prime minister Ayad Allawi requested NATO support to his government through training and other forms of technical assistance. Alliance presidents and prime ministers responded positively, offering NATO's assistance to the government of Iraq with the training of its security forces. They also encouraged member countries to contribute to the training of the Iraqi armed forces.

The North Atlantic Council, NATO's senior decision-making body, was tasked to develop, on an urgent basis, the modalities to implement this decision with the Iraqi interim government.

The Training Implementation Mission

These modalities were agreed on 30 July and established a NATO Training Implementation Mission in Iraq. Its goal was to identify the best methods for conducting training both inside and outside the country. In addition, the mission immediately began training selected Iraqi headquarters personnel in Iraq. The first elements of the mission deployed on 7 August.

Expanding NATO's assistance

On 22 September 2004, based on the mission's recommendations, the North Atlantic Council agreed to expand NATO's assistance, including establishing a NATO-supported Iraqi training, education, and doctrine center in Iraq. In November 2004, NATO's military authorities prepared a detailed concept of operations for the expanded assistance, including the rules of engagement for force protection. On 9 December 2004, NATO foreign ministers authorized the Supreme Allied Commander Europe (SACEUR) to start the next stage of the mission.

The activation order for this next stage was given by SACEUR on 16 December 2004, paving the way for an expansion of the mission to up to 300 personnel deployed in Iraq, including trainers and support staff and a significant increase in the existing training and mentoring given to mid- and senior-level personnel from the Iraqi Security Forces. It also changed the mission's name from NATO Training Implementation Mission to NATO Training Mission-Iraq. By the time of the NATO summit meeting in February 2005, the new mission was fully staffed and funded.

Who is in charge?

The NATO mission is distinct, under the political control of NATO's North Atlantic Council. It is coordinated with the Multi-National Force-Iraq (MNF-I).

The commander of Multi-National Security Transition Command-Iraq is also the commander of the NATO effort. On NATO issues he reports up the NATO chain of command to NATO's SACEUR and, ultimately, the North Atlantic Council.

MNF-I provides a secure environment for the protection of NATO forces in Iraq. The NATO chain of command has responsibility for close area force protection for all NATO personnel deployed to Iraq or the region.

The National Defense University, set up by NATO, comes under the authority of the Iraqi Training and Doctrine Command, which establishes the framework of training matters for all Iraqi military schools.

Annex C, Appendix 5

Engagement With the Media

Provincial reconstruction teams (PRTs) have an important role to play in ensuring that progress is being made and that the benefits are communicated to local communities, to the Iraqi people as a whole, and to international audiences. Having an Iraqi face associated with success is key to building the legitimacy of local governance, which greatly assists in building and maintaining public understanding, acceptance, and support for the work of the U.S., international community, nongovernmental organizations, the government of Iraq, and Multi-National Force-Iraq (MNF-I)—both in Iraq and more widely. Without this support, both in Iraq and among the international public, PRTs cannot achieve operational success. The media is the key conduit to both these audiences.

To help convince people that PRTs and the coalition are making a real difference, it is essential that PRTs are able to identify examples of success; develop these into useable media products; and exploit the information through local, regional, and international media outlets, as well as through face-to-face contacts with key local leaders and influencers. This procedure requires close coordination with key delivery partners and developing excellent relationships with the media, through regular, personal contact at a senior level, which also help associate PRTs with positive outcomes.

While a proactive approach to media relations is important, so is the ability to counter negative coverage of U.S. military activities. PRTs should monitor media outlets to maintain effective situational awareness of media reporting trends and be prepared to rebut inaccurate reporting promptly when necessary. Interpreters and locally employed civilians can be used to assist in this regard.

Embassy PRT Media Relations Guidance

It is important that PRTs in Iraq communicate about their activities and achievements through the media. The U.S. embassy has considerable expertise in a wide range of areas, and PRTs can use this expertise to ensure accurate reporting on issues and events of importance to the U.S. Government.

While encouraging dialogue with the media by mission staff, the ambassador has directed that all mission personnel coordinate their interactions with the press through the embassy spokesman's office. PRTs should follow the guidelines below in matters involving the media:

- If you are contacted by a journalist for an interview or comment on an issue in your area of expertise, please refer them to the embassy spokesman's office. A press officer, working with the embassy spokesman, will follow up with the journalist and then get back to you.
- If a journalist contacts you concerning an issue outside your area of expertise, likewise have them call the embassy spokesman's office, which will evaluate the request and send it to the appropriate embassy officer for a response.

CENTER FOR ARMY LESSONS LEARNED

- If you are contacted by a journalist and asked for an impromptu comment or interview on any subject, politely decline and refer the person to the embassy spokesman's office.

Once the embassy spokesman's office gives you permission to speak with the media, your discussion with the journalist should, as a general rule, be "on background" with agreed attribution (e.g. "Western official," "Western diplomat," etc.)—the journalist can then quote you, using the agreed-upon attribution.

When speaking about a particularly sensitive issue, your comments should be "off-the-record," meaning that the journalist cannot attribute the information to anyone or any source. With few exceptions and unless explicitly approved, you should not speak "on-the-record" because that means you will be quoted and your name will be used. Only the ambassador, deputy chief of mission, directors of the Iraq Transition Assistance Office and U.S. Agency for International Development, and embassy press officers should speak on-the-record.

If requested, the embassy spokesman's office will provide a press officer to sit in on media interviews and also will provide a tape recorder for taping interviews.

Be circumspect—be aware that any exchange with a journalist, even in an informal setting, can be used by that journalist in their reporting.

Questions about matters related to MNF-I will be handled by the MNF-I public affairs office.

Regional Embassy Offices (REOs)

The mission's REOs should refer media requests to the foreign service officer responsible for the REO's public affairs portfolio. If the request is from local media and concerns local or regional issues, that officer will coordinate with the journalist as described above; there need be no embassy involvement. Media requests to REOs involving national or international media or highly-sensitive/controversial issues, should be referred to the embassy spokesman's office.

Annex C, Appendix 6

Local Governance Program

The Local Governance Program (LGP) supports Iraq's efforts to establish local government that is transparent, accountable, and responsive to its constituents. LGP, which began in April 2003, operates under a contract from the U.S. Agency for International Development. LGP was expanded in 2005 to include a new phase of support for local governance programs in Iraq.

Under terms of its contract, LGP:

- Supports Iraq's efforts to improve the management and administration of local, municipal, and provincial governments.
- Provides technical assistance and training to local elected officials concerning the roles and functions of local government officials and agencies.
- Assists in establishing a legal framework for a democratic, representative, and participatory form of decentralized government in Iraq.

Since May 2005, LGP has been training and mentoring provincial councils elected in January of that year in the roles, responsibilities, and authority of the provincial councils and also providing similar training to Iraq's network of local councils.

LGP's earlier work in Iraq (June 2003–April 2004) included supporting the establishment of more than 700 local government councils. During that time, an in-country team of nearly 3,000 Iraqis and more than 220 international development specialists worked throughout Iraq's 18 provinces on a wide range of locally selected priorities. These included such varied topics as increasing access to basic utilities and health care and establishing and training local governing councils. The work with Iraqi civil society focused on empowering women, youth, businesses, farmers, and others to organize, advocate, and work for a democratic and tolerant Iraq.

LGP supports the provincial reconstruction team (PRT) effort in nine provinces across the country by providing technical advisors in areas related to governance, policy reform, and economic development. From its headquarters in Baghdad, LGP oversees operations of its regional hub offices in Irbil, Hillah, Basra, and Baghdad, serving all 18 Iraqi provinces.

LGP is implemented by RTI International and its technical partners include Bearing Point, Inc., Creative Associates International, the International City/County Management Association, and VNG International.

Annex D

Best Practices

Governance and Rule of Law

Provincial government (PG) mentorship program

How does the provincial reconstruction team (PRT) develop/influence leaders at the PG to practice good governance and to accelerate reconstruction and development?

Provinces often lack enough qualified people to fill positions in the PG. The basic executive, managerial, and technical skills required for provincial ministerial director positions often need to be developed on the job. As a result, the PRT must build the needed institutional capacity within the existing PG.

PRTs can address this problem by creating a mentorship program. This program would link peer mentors (select members of the PRT and the adjacent maneuver unit staffs) with key members of the PG.

Program managers can be selected from both the PRT and PG staffs to shape the mentorship program and scope the main objectives. The PRT must conduct an internal talent assessment to inventory available skills and experience available within the PRT and adjacent maneuver units. The PRT and maneuver unit commanders, working with the governor if possible, can then assess the PG to establish a priority of effort targeted at key positions. The program managers then develop a structured plan and match available resources to PG staff for capacity building.

Suggested approach

Develop the scope of the program, select your team, and gain PG buy-in.

- **Selecting a program manager.** Select a program manager early within the PRT to shape the program and guide its initial launch. Although the PRT commander should provide his intent and shaping guidance, he should not take the lead on this project. Launching and running a successful program will require significant effort that will likely conflict with the PRT commander's other activities. Ideally, a counterpart within the PG should co-lead the program. This could be the governor, the chief of administration, or someone within a staff that has significant knowledge of and influence over peer directors.
- **Assess internal resources (talent inventory).** Assess internal resources to determine available skill sets. Consider personnel outside the PRT organization, expanding the screening process to co-located maneuver and support units or nearby forward operating bases.
- **Gain PG buy-in.** This program requires "top-down" support from the provincial governor and key ministry directors. However, the program manager and PRT commander should understand their available resources and skill sets before approaching the provincial governor with

this program. Using output from the skills inventory, a detailed understanding of available PRT and maneuver unit staff will allow the PRT to set realistic expectations and help guide the subsequent matching of mentors with appropriate provincial staff. This initial analysis supports the first discussions and manages expectations of the governor and key PG staff on the scope of the mentoring program and level of expertise available at the PRT and nearby military units.

- **Assess PG and key staff.** When making this assessment, the program manager should consider both the available staff and the province's critical needs. Assessing the critical needs of the province includes key ministry directors and their respective capacities.
- **Launching the program.** Once the PG agrees with the scope, approach, and goals of the program, implementation of the mentorship program can begin.
- **Kick-off meeting.** Launching the program with clear direction and a robust plan increases the likelihood of success. It is important to ensure the program objectives are clear and shared, roles are defined, and both mentors and counterparts understand the processes for interaction.
- **Initial meetings.** Matching mentors with the appropriate counterparts is a key initial task. As the host country has a specific type of society, culture, and education level, consideration should be given to matching mentors with appropriate counterparts. Matching a younger Soldier or staff with a much older counterpart is unlikely to be effective. These relationships would be better positioned from the outset as supporting or technical-skills-transfer relationships rather than as management-mentor relationships.
- **Coordination with governor.** Throughout the entire process, the PRT coordinates all efforts with the PG to ensure unity of effort. Additionally, the PRT can use this event as a teaching and mentoring tool to show the PG that local leaders can solve key issues of importance to the PG and the local people.
- **Ongoing collaboration.** One approach is to focus the collaboration around a specific project. However, the mentor should resist the urge to take over doing the work. The mentor should help his counterpart to develop and consider options for solving problems.
- **Program evaluation and internal reviews.** The program manager should set out a system to evaluate progress against established and agreed-to criteria. Effectiveness of the mentor-counterpart relationship is assessed by the provincial governor, PRT commander, the PG, and PRT program manager.
- **Transition plan.** Ideally, mentor-counterpart relationships should be transitioned to incoming PRT and maneuver units based an internal assessment of the people on the new team (see "Assess internal resources" above). Priority should be to cover the key positions in the PG, as significant benefits come from continuity in coaching PG members to

be better managers. Specific technical subject-matter expertise for mentoring line ministry skills may not be available in the next PRT. The PRT should maintain awareness of other experts within the wider community (other PRT staffs, Combined Joint Task Force [CJTF] and other staffs, as well as in the interagency community). However, the main focus of the mentoring program involves the transfer of basic management skills. As this basic mentoring does not require specific subject-matter expertise, it should be possible to match incoming staff with current PG staff counterparts for continuity of key relationships. This may mean shifting mentor roles to tenant units. When possible, mentor roles and activities should be covered during the “right-seat, left-seat ride” transition.

Measures of effectiveness

- Numbers of key PG staff covered by program (e.g., number of officials with assigned mentors)
- Role profiles developed
- Self-assessment and individual development plans
- Self-assessed progress against development plan
- Objective assessment against development goals (mentor +)
- Internal staff effectiveness goals and measurement means developed

Leadership Engagement Under Difficult Conditions

How can the PRT advance its long-term mission of enhancing good governance when the current key leaders (provincial governor and police chief) are corrupt and/or ineffective, all while maintaining an objective position? What levers are available to the PRT to influence better behavior and performance?

The reality on the ground is that some provincial officials will not act in the people’s best interest due to corruption, incompetence, or both and, at times, may be uncooperative. The coalition’s goal is to enhance good governance and encourage transparency. Although the PRT would prefer to avoid associating with corrupt, ineffective government leaders, in the short term, the PRT is required to maintain a professional level of engagement with the existing government. A principal PRT mission is to influence good governance, assist in building institutional governance capacity, and support strategic reconstruction in its area of responsibility (AOR). In order to accomplish this mission, the PRT needs to engage continually with the provincial leadership and increase access to other ministry directors to build institutional capacity.

One way to address this problem is by maintaining a working relationship with the governor and police chief while simultaneously engaging the PG at multiple levels across key provincial line ministries. Regardless of the quality of key provincial leaders, PRTs need to continually engage with key leaders while expanding knowledge and relationships across the government. The PRT must employ practical techniques to build governmental capacity.

- Use access to wider PG contacts to communicate (re-emphasize) coalition policy on corruption and counter-narcotics; deliver similar messages in public forums.
- Diplomatically deliver consistent message in private forums, reminding government officials of their duty to uphold the rule of law and govern in the interest of the people.
- Always maintain a dialogue for information sharing on security matters and reconstruction planning. Avoid reconstruction support unless controls are in place (see “Life cycle project management” below).
- Provide assessments of key leaders through command channels to influence the central government to make changes in the key provincial leaders.

Suggested approach

Assess the PG (line directors and staff). In most cases, some line ministry directors are ready to work with the PRT. Department of State (DOS) representatives can help maintain the relationship map of provincial officials.

Use available resources (time, Commander’s Emergency Response Program [CERP] funding, and associations) to influence and reinforce good behavior:

- **CERP projects.** Work with PG line ministry staff to address projects that can provide timely impacts and be visible to the people. PG directors who are ready to work transparently and to the benefit of their constituents are rewarded with follow-on funding for projects of similar merit. Look for opportunities to engage with less-effective PG staffs during the process. Encourage the PG staff to participate in the progress. Manage possible obstacles to progress closely.
- **Developing institutional capacity.** Collaborating on a specific project or program with a line ministry director and staff can be an effective vehicle for building capacity. Mentoring programs can help build skills with other PG members, after gaining buy-in from the governor and line directors to work with their staff.
- **Consider phased development/investment to control funds.** Phased project execution allows the PRT to invest in projects that are being managed with transparency and effectiveness. Involving local leaders in shaping projects and creating local work crews can yield the optimum economic benefits while putting in place good project controls for CERP funds. This phased approach also allows adequate time for teaching.

Update assessment of PG staff and progress:

- **Reassess the PG.** As the PRT continues to engage the PG, subsequent assessments should be made periodically. These assessments should be based on the criteria established in the original assessment of the province.

Measures of effectiveness

- Level of engagement with extended PG, including key line directors for progressing reconstruction and development
- Number of effective relationships across the PG
- Level of collaboration on reconstruction planning; number of PG staff members engaged for mentoring and training
- The number of reconstruction projects completed in collaboration with PG directors
- Frequency and effectiveness of the collaboration on security matters

Conduct and Sustain Religious Leader Engagement

How does the PRT influence people?

The PRT can engage key populace groups by using religious leaders. Religious leaders are key members of society and can influence the actions and opinions of the local population. The PG and the PRT need to engage this group in a forum to understand their perceptions, build trust, improve perceptions, and proactively respond to their concerns.

Religion is an important factor in the modern culture. Although religion is important to many in our society, it is usually quite separate from our government and educational systems. To truly understand some cultures, one must fully grasp the importance religion plays in almost every aspect of life. Religious leaders hold positions of power, are much respected, and have the ability to heavily influence their followers' lives. Building a good relationship with them in your province is essential for the coalition. The PRT is in the best position to establish this relationship in conjunction with the PG. Failure to understand and respect the religious culture could have serious repercussions (e.g., an act, intentional or not, that might be repugnant to Muslims could be mitigated if there is a good relationship with the mullahs in your province). By building relationships with religious leaders, the PRT can understand their perceptions, build their trust, positively influence their perceptions, and proactively respond to their issues. It is important to involve the PG when interacting with religious leaders. This involvement will encourage both the PG and religious leaders to participate in civil society by reaching out to the local population.

Building relationships with religious leaders can provide a variety of positive effects for the PRT. Including religious leaders in the reconstruction decision-making process can positively focus their energies and give legitimacy to the projects. Additionally, there will be improved relationships with the religious community and, consequently, with the populace. These relationships will increase the awareness of the PRT on sensitive religious issues. Once good relationships have been established with these leaders, the PRT's influence with those that wield the most power in the community will increase. Good relationships encourage all parties, the PRT, the religious leaders, and the PG to consider all the issues.

The PG needs to engage religious leaders and draw them into civil society activities:

- Invite the religious community in the province to a meeting called by the governor. By having the PG invite them, religious leaders are protected from the perception that they are collaborating with the coalition. It is important to clearly identify your audience and where they come from regionally. Knowing your audience is important to any successful engagement.
- Attend the meetings with a minimum number of military and U.S. Government (USG) personnel. Use one scribe so the PRT commander can maintain maximum eye contact and gauge the crowd. Bring interpreters to the meetings to catch sidebar conversations. Have the interpreters take any photographs because religious leaders often think that the U.S. military is taking pictures for intelligence-collection purposes.
- Use the initial forum to explain coalition objectives and review reconstruction activities, while reminding the group of the positive contributions the coalition reconstruction efforts are making.
- Allow religious leaders to vent their grievances; at the same time use the forum to encourage them to act.
- Maintain follow-up contact and begin to develop an actionable plan to address possible negative perceptions. For follow-on meetings, an agenda including both the coalition's and mullahs' topics should help guide and control the length of the meeting.

Suggested approach

The PRT should enlist the help of PG members (e.g., provincial governor and director from Ministry of Religious Affairs) to convene the meeting. Encourage the participation of all key religious leaders in the province. Work with the provincial director of religious affairs to plan the event and agenda format. Ensure the agenda is circulated among invitees prior to the event. Remember that meetings often get off track and will go longer than anticipated if you do not have someone controlling the meeting. Select a secure venue, preferably a local government site and not the PRT or U.S. military site. It is polite to serve refreshments or lunch for all attendees. To transition this to the next PRT set up a meeting of the primary attendees and introduce the new PRT during the relief-in-place (RIP) process. It is important to relay as much information as possible about the religious leaders to the incoming PRT members.

PRTs should introduce incoming commanders and/or civil-military operations center (CMOC) chiefs to the PG. Provide background on the PG (can use DOS profile). It is important to transition working relationships to the incoming team.

Measures of effectiveness

Although there are not specific objectives to measure success, the following areas can give indications that conditions are getting better. Even though the first meeting may have a large audience of religious leaders, the attendance at meetings that

follow will indicate your success. The number of civic disturbances involving religious issues should decrease with positive interaction with local religious leaders. The tone of the meetings should shift from violent shouting or indifference to meaningful dialogue and interaction. An increase in the number of meetings initiated by religious leaders via a request to the governor would be another sign of success.

Conducting Information Operations Using the Local Media

How does the PRT reach the populace in the province with targeted messages that build awareness and support for the local government and the coalition's effort?

The challenge is that there may be little in the way of established communications systems and media. PRT commanders can work to enhance public information while enabling their own information operations campaigns. It is important to engage with the local government officials and allow them to deliver a message of progress to the people. Sometimes due to expediency, the PRT commander or a member of his staff may provide the remarks at an event such as school opening or preface the translation of a speech presented by key members of the local government. Regardless of the need (and often encouragement) for U.S. military personnel to deliver these messages, the messages would have a better effect on local readers and listeners if they were delivered by a local government official.

Although information operations may attempt to reach multiple audiences (e.g., U.S. citizens, the international community, deployed coalition forces, and locals), the PRT's primary audience is the provincial populace. However, there are limited resources provided to the PRT to reach that audience effectively. A local newspaper, one that focuses mostly on stories of national-level interest and stories that promote coalition efforts, should be engaged. Some regional content can be introduced to provide news and targeted public information in the province. There may be a dearth of local language content available for public information. In the end, the people may have little information about their local government at a time when the government needs to build awareness and engage its people in the civil processes of a democracy. The PRT commander needs to reach out to the local audience. He can do this by contacting the state-run television station operating in the provincial capital.

You can take a state television station's camera crew to an event to have local media document the engagements and provide commentary for the event. This practice shows the people of the province that their local government is working toward providing better services for its people and explains how the government is accomplishing this enormous task. The coverage should be balanced and fact-based, discussing the challenges the country faces. If the government is not doing a good job, the news report should show that as well. Because the engagements involve the local government and do not revolve around the direct actions of the PRT, this practice helps to dispel many of the myths about coalition forces .

The initial videotaping of a governor's meeting with religious figures where the PRT commander is also in attendance can receive a lot of attention. The PRT should continue to work with the local government on the concept of providing public service messages. One of the goals would be to work toward collecting

revenue based on selling advertising slots. The end result of implementing this practice is the creation of media coverage that will promote the PG's activities and provide public service information.

Suggested approach

Coordinating the concept:

- **Selecting a program manager.** To ensure that a coordinated effort is possible, the PRT should select its civil affairs team (CAT) team leader to monitor this program.
- **PG interest.** The PRT commander and the program manager meet with the governor and the director of communications to propose, refine, and agree upon the idea being proposed. At the meeting, present the basic concept and review the media capabilities in the province. The PG should agree that the people have a great interest in what goes on in the province and that a more aggressive plan on managing the message could help the people understand how their government is supporting them. The communications plan could also help in the area of public service messages by addressing such issues as health.

Conducting a provincial media assessment:

- **Types and location of media assets.** The program manager should work with the director of communications to agree upon a basic coverage concept of the current media facilities and develop a broad vision of where the PG wants to expand its current resources. The PRT AOR may have state-run television and radio, as well as private television stations, that reach a large part of the populace due to high population densities in several key areas. The province may not have local print media.
- **Capabilities of the local television station.** The PRT can approach state-run television stations and invite them to cover and record events such as project groundbreakings, grand openings, village medical outreaches, and PG-sponsored religious meetings. The television station may be interested in covering these events but lack basic audio/video equipment. The PRT can purchase a small portable video camera and basic video equipment and give it to the station. The station can then send a cameraman out with the PRT to cover key events occurring in the province.

Working with the state-run television station:

- **Basic media training.** The program manager should work with the local media to help improve their presentation techniques for taped segments. The PRT can encourage the television station to interview members of the PG as part of the film clip introduction. The cameraman can also interview people attending key events to capture their impressions of the event or efforts of the PG. Covering these events leads to more PG involvement and brings a local perspective to the events.

- **Preparing the message for radio and print.** Another benefit of helping the television station create content is that the same content can be used for radio (audio) scripts and played on the radio across the province. The scripts can also be used for print media.

Involving the PG:

- **Public service messages.** The PRT should work with the director of communications and/or the state-run television station to help it package ideas and promote positive public service messages to the province. One planned campaign idea could be sponsored by the director of health to combat a local epidemic that is a common cause of mortality (e.g., the public service message could help dispel the myth that giving more water to infants with dysentery results in their death due to dehydration). The PRT can also help the communication director or television station make radio and TV spots.
- **Expanding media coverage.** Current coverage may be limited. The PG has a plan to increase coverage but needs assistance in financing the hardware upgrades. The station could consider selling airtime to businesses for advertising or to nongovernmental organizations to air information and outreach programming (e.g., farm extension programs and teacher training). The PRT could consider buying airtime for public information campaigns highlighting public health and safety issues or for promoting events such as village medical outreach events.
- **Radio distribution.** The PRT should have money to distribute radios to areas that the signal covers but where people do not have radios. This will maximize the efforts of getting information to the people.
- **Transitioning practice to the next PRT.** The PRT must understand that the PG controls many of the media resources. The PRT should monitor the PG's usage of the systems and suggest modifications to the process when it identifies areas where the PG could benefit.
- **Transitioning practice to the PG.** The director of communications should develop a media campaign to keep the people informed by having the PRT maintain a good relationship with the director of communications and assist in getting the governor to understand the importance of this communication tool.

Measures of effectiveness

- Number of listeners, watchers, and readers.
- PG establishes public service messages that reach more people in province (coverage).
- PG provides upgrades to the television and radio stations.
- PG establishes a print media capability.
- Television and radio stations start collecting advertising revenue.

Reconstruction and Economic Development

Life cycle project management

How does the PRT manage multiple projects to support reconstruction and development in its AOR?

The PRT staff must efficiently and effectively manage available resources, including delivering projects at the desired quality levels, building project management capacity in the PG staff, and building capacity in host country enterprises.

One PRT addressed this problem by viewing CERP project management as an end-to-end process from the project formation/generation phase through project closeout and post-delivery monitoring.

The PRT has organized a project delivery cell with defined roles and a mix of technical project management and control skills.

Key supporting processes

- **Project generation and nomination process.** (see “Collaborative reconstruction planning with provincial and local governments” below)
- **Standard design for projects.** U.S. Agency for International Development (USAID) and United Nations Office for Project Services (UNOPS) have standard designs that use simple construction techniques and local materials. One PRT keeps an archive of all standard designs for a range of possible projects (e.g., schools, basic health care clinics, and micro-hydroelectric plants).
- **Pre-bid supplier conference.** Use the conference to describe the project, the expected skills required to deliver, and quality expectations. Set expectations and describe the way PRTs work, progress payments, and the quality dispute process.
- **Bidders conference.** One PRT expands the pre-bid conference into a training session. The PRT developed a training manual that is distributed at the pre-tender bidders conference. Attendance at the course qualifies the contractor to bid on CERP projects. The certification course aims to orient potential contractors, set their expectations, and prepare them for successful performance on CERP projects.
- **Supplier information management.** Provide contractor/supplier profile with picture for positive ID. Maintain records on each supplier to include previous work performed and references from other work. Assess and record previous level of performance and capabilities (e.g., trades covered and geographic scope of operations).
- **Build detailed request for proposal/quote.** State quality expectations in bid documents so cost of quality can be reflected in the contractors’ pricing. Communicate the quality expectations in the request for

proposal/quote document. Reinforce the message again during the certification course.

Suggested approach

Organize project delivery cell:

- **Develop project documents.** Plan project documents in adequate detail to support clear communication with potential bidders (i.e., provide contractors with the scope and requirements for the project). These documents can be used to support the bidders conference and the core of the bid package.
- **Plan and hold bidders conference.** Organize and hold the conference. Rehearse the presentation of the bid documents with the interpreters to ensure requirements are clearly communicated. Leave enough time for clarifying questions from the contractors. Answer all contractor queries in public, allowing the entire group to hear all questions and the same answers. Explain the ground rules for bid and who is on the selection committee.
- **Gathering and managing project and supplier information.** In most provinces some line ministry directors are able to work effectively with the PRT. Assess the PG line directors and their staff to determine their willingness to work transparently with the PRT. Use DOS representatives to help assess current PG staff and maintain the influence-relationship map of key provincial officials.

Use available resources (time, CERP funding, and associations) to influence and reinforce good behavior:

- **CERP projects.** Work with provincial line ministry directors to assess the province's needs and develop a prioritized development plan. Build sustainable systems by thinking through the resources for construction as well as the operating cost to maintain the system.
- **Developing institutional capacity.** Collaborative project work and mentoring programs can help build skills with other PG members. After gaining buy-in with staff collaborations from the governor and key line ministry directors, form the appropriate working team to develop and management projects. Ensure the governor and key line ministry directors are kept informed through open progress meetings. By inviting larger participation from the line ministries, the PG can develop greater knowledge and experience in project development and management.
- **Consider phased development/investment to control funds.** Phased project execution allows the PRT to invest in projects that are being managed with required transparency and effectiveness. Involving local leaders in shaping projects and creating local work crews can yield the optimum economic benefit while allowing good project controls of CERP funds. This phased approach also allows adequate time for teaching.

Measures of effectiveness

- Number of responsive bidders.
- Number of certified contractors (trained).
- Percentage/number of significant quality issues surfaced on CERP projects. Compare two populations: certified contractors versus uncertified contractors (i.e., set up population samples of projects completed by certified vs. uncertified contractors). Measure frequency and magnitude of quality issues surfaced on projects with certified contractors vs. uncertified contractors.

Collaborative Reconstruction Planning With Provincial and Local Governments

How does the PRT partner with provincial and district officials in order to build organic capacity in the PG?

The PRT needs to encourage ownership of identification, prioritization, and project-shaping steps and ensure that CERP and other available reconstruction and development funds support Coalition Force Command (CFC) lines of operation (LOOs) and Commander, Combined Joint Task Force (COMCJTF) focus areas. The PRT is responsible for making sure that these funds achieve the desired tactical/operational effects in the province.

- Develop a collaborative process working with PG and interagency team to assess needs and develop a prioritized plan. Use forum for project selection and planning.
- Develop an integrated project delivery team by using available resources in PG and districts.

The PRT must develop a structured, collaborative process for province-level planning and prioritization (under constrained scope and resources). The PRT works with the PG to ensure the right stakeholders are engaged and that they take ownership of the planning process. The PRT takes command guidance and applies it to specific AORs to prioritize sectors, geographic areas, and execution timing to optimize effects of delivered projects. The commander and the CAT translate guidance into criteria and steer the PG to desired areas. These criteria manage the expectations of the PG while reducing wasted effort and encourages open exchanges of information on the actions of other development actors working in the province.

Suggested approach

The PRT commander must consider CFC LOOs, specific commander's intent from COMCJTF priorities, and sectors for investment focus. The PRT commander then takes input from maneuver units to focus areas of particular tactical/operational importance and apply the applicable time windows. The commander then arranges a meeting for all key ministry directors. After this meeting, the commander develops an action plan to prioritize projects.

A good opportunity to test this process is during a CERP campaign plan and broader project plan. The projects selected for a specific campaign should be the outcome of numerous meetings with provincial ministry directors. After intense engagements, a number of directors will develop project lists and, in some cases, have prioritized them. These lists are the basis of the campaign plan.

A host country leads the delivery model, encourages long-term ownership, and builds sustainable capacity in the province.

- CAT and project management cells need to deliver projects to the desired quality standards while building capacity in the provincial and local governments to manage similar projects. The PRT also needs to help develop a pool of contractors and material suppliers in the province that can deliver services and goods of the required quality. Using supplier development techniques via teaching and feedback and upholding quality standards ensures this pool of qualified suppliers is available in the province.
- Once a project is nominated and approved, the CAT engages interested members in the PG to develop the statement of work (SOW) that is included in the request for proposal document. The PG shapes the specific project scope to ensure it meets the intended requirements, thus reducing the risk of change orders after the contract is awarded.
- Once the project scope and high-level SOW is determined, the CAT closely manages the solicitation process. PG officials and PRT government staff interpreters are purposely kept out of the process and information flows during the bidding, evaluation, and selection processes.
- Once the contract is awarded, the PRT team holds an on-the-ground preconstruction meeting with the PG and local officials responsible for assisting with monitoring the construction and accepting the work/asset at completion and turnover.
- CATs are becoming more and more successful in instilling a sense of ownership for projects in local governmental officials. In addition to involving them in the campaign plans, local governmental officials have accompanied CATs to conduct project assessments/site visits. Directors are also taken on weekly quality assurance/quality control (QA/QC) visits of the projects that fall under their purview and are forced to interact with contractors to ensure the project meets their standards. In some cases, the PRT is working through the most competent and motivated directors to execute projects by providing the materials and having the director organize the project, the engineer/expert, and the workforce. This technique further instills a sense of ownership that is critical to ensuring the people associate the director and the local government with the project, rather than the PRT.

Integrated self-managed project delivery approach

PRTs must take unique approaches to encourage the PG and local officials to shape and deliver projects independently using host nation local managers and workers. The PRT helps the PG shape the project by providing guidelines on scope and researching resources for the projects (e.g., construction materials). The project is

self-managed by PG and local government. The PRT serves as an investor and advisor during the entire project, only stepping into the direct management role when absolutely necessary. The process encourages ownership and problem-solving skills in the PG and local community. When appropriate, the PRT leverages USAID Alternative Livelihoods Program (ALP) cash-for-work labor managed by the local community. The ALP pays the daily wage for manual labor and some skilled labor for projects associated with counter-narcotics efforts, such as rehabilitating the irrigation system or improving roads to facilitate getting legitimate products to market. The PRT uses CERP to purchase the materials and tools for these projects. This method has enabled the PRT to conduct projects through the directors and make CERP money go farther. As more and more projects are completed in this manner pressure is placed on contractors to lower their prices to a more reasonable level.

Benefits

- Builds project delivery/management skills in the PG.
- Puts PG between the contractor and PRT, which engages the PG and builds its leverage with suppliers. The PG collaboration with the PRT also provides a process for building technical and project/contract management skills within the PG.
- Partnering with responsible directors has helped in determining fair market prices for CERP projects. The directors of irrigation and rural rehabilitation and development have been critical partners in keeping the CAT abreast of market prices for well drilling and prices for cement and other materials. Additionally, close relationships with the mayor can result in free access to the fair market price list for all commodities in the bazaar. All prices are controlled (and taxed) by the mayor and therefore he ensures that merchants are not gouging PRT personnel.

Suggested modifications

Where possible, further refine the scope of work and SOW to support the bidding process. A detailed bid document that describes the required work builds capacity in the PG on the type of preparation required to support transparent tenders. It is best to eliminate all possible ambiguity in the bid document. Thorough preparation of bid documents reduces risk of overbidding or underbidding on a project. Underbidding is particularly risky, causing friction in contracting relationships that could influence quality issues (or in the worst-case scenario, non-performance via default). The site walk with PG officials can easily be done before the scope, design, and statement of work are finalized for the request for proposal document.

Efficient sourcing to maximize scarce resources

PRTs need to use available CERP funds most efficiently as a catalyst for provincial reconstruction and development. The PRT must be aware that paying significantly above-market prices for local goods can create price distortions in the area. However, the PRT may not have experience in sourcing materials and services in all districts and have neither price benchmarks nor the ability to attract an adequate number of qualified bidders to generate enough competition to get actual market pricing. PRTs can use multiple inputs from trusted PG officials to negotiate the market price. The PG understands that the PRT's budget is fixed and that more

reconstruction can be done if fair market prices are negotiated for goods and services.

Coordinating Reconstruction and Development With International Organizations and Nongovernmental Organizations

How does the PRT help the PG create a forum to engage with potential donors for situational awareness, sharing of ideas, integrating development plans, and optimizing the use of limited resources?

The PG needs a means to meet and discuss reconstruction and development issues and plans with all external actors (potential donors and implementing partners) concerned with and active in the province. A forum to allow for exchange of information for all parties involved is helpful. The advantage for international organizations (IOs) and nongovernmental organizations (NGOs) is to learn about the needs/plans of the PG and the threat situation within the PG's area. The forum allows the PG to present its needs/wants to donors. The PRT can use this forum to assist in deconflicting projects between agencies and optimize the use of limited resources. This forum is also an opportunity to increase the types of projects because of the diverse group of donors.

By holding a forum with potential donors, the PG is able to have a larger stake in the selection process. The United States cannot afford to pay for every project that each PG would like to have. There is often distrust by non-military organizations toward the military. Overcoming this distrust can be accomplished by encouraging the PG to take the lead in conducting the meeting. Additionally, sharing this information might break down many of the barriers that have developed between the PRT and non-military organizations because they do not understand each other. Including all willing donors in the provincial reconstruction and development plan can increase monies, decrease potential conflicts, and provide necessary information that IOs/NGOs need to operate.

One PRT addressed this problem by getting the PG to host a monthly meeting that brought potential donors together. The governor had some of his directors brief the overall provincial reconstruction and development plan and then asked the donors to come back at follow-up meetings to donate resources to support the PG's plan. If the PG does not currently hold this type of meeting, the PRT can facilitate such a meeting by providing a basic security briefing for the IOs and NGOs in the province. After donors start attending this meeting, it can be transitioned into a PG-led donor meeting. The PRT must work with the PG to ensure it understands the meeting's importance and the benefits of advertising their plan to donors instead of trying to get the PRT to lead the effort.

A PRT might assist the governor and the minister of education in developing a media campaign for their trade school. The PRT can get the PG involved at all levels. Flyers can be distributed by members of the national army, national police, ministries, and district leadership. The PG can also select students for each of the classes. A radio message can be developed to disseminate the news. Future coverage of the school can be discussed to ensure that the people know about future classes, and that the PG gets credit for this program.

Suggested approach

Coordinating the concept:

- **Getting started.** The PRT selects a program lead (someone who is knowledgeable on project management), initiates the CERP planning process, and assesses the reconstruction and development situation in the province. Although USAID has the lead on reconstruction and development, the PRT CMOC team can contribute significantly to this effort and often can provide perspectives on the specific districts throughout the province. The PRT commander must engage with the governor to ensure that he understands the necessity for a coordination meeting that is led by the PG and not the PRT. Some governors understand this so well that they are starting to travel abroad looking for donors to support their reconstruction and development plan. The program lead should compile a list of potential donors within the province, as well as the surrounding provinces. The information from the surrounding provinces is important because they might have a resource needed in your province. This data collection should include donors that were here in the past. This historical information may not be easily available, but when conducting missions, signs are often present that convey who built a particular item and when it was built. The Ministry of Rural Rehabilitation and Development (MRRD) and the United Nations (UN) are good sources for discovering donors currently working in the province. It is possible that some donors avoid working in a province based on an inaccurate perception about the security environment. By guaranteeing the donors' safety and advertising a true need in the province, the PG might encourage donors to come into their province.
- **Provincial reconstruction and development plan.** The PRT commander and PRT staff must engage with the PG to determine if there is a plan for reconstruction and development. The easiest thing to start with is the road network. Many PRTs do not receive historical data during their transition; however, the PG should be the main source for the PG reconstruction and development plan. In the absence of a plan, the PRT should not make one. However, the PRT should guide the governor on the subject of reconstruction and development. Ultimately, the reconstruction and development plan is the PG's responsibility. Delays in the planning process will affect the PRT's ability to donate CERP funds. This can be a powerful tool to get the PG into the planning process.
- **Gaining donor interest.** Without providing any classified information, the PRT should prepare a briefing they can share with IOs and NGOs. These organizations are always concerned with security assessments; therefore, the information available from the PRT provides a carrot to get IOs and NGOs to attend the coordination meeting. It is not a good idea to hold this meeting at the PRT. There is a better chance of IOs and NGOs attending if the meeting is in a neutral location. Some PRTs have held the meeting at a PG building or UN facilities. If no such meeting exists, it is essential that the PRT contact potential donors and offer a security briefing and baseline common operational picture (COP). Before providing maps, ensure that you check to see that doing so does not violate any governmental laws or policies. Some regulations prohibit the

U.S. military and agencies from providing maps to others. After conducting the meeting a few times, it would be appropriate to start discussing reconstruction and development and see where seams and gaps exist. This helps deconflict support efforts between all these organizations.

Three-phase meeting approach for PGs that currently hold PG donor efforts

Because the nature of providing donations can be potentially embarrassing as well as competitive, it is best if donor efforts are conducted during three separate engagements: PG donor meeting, donor resource meeting, and PRT provincial development meeting.

- **PG donor meeting.** The governor hosts the meeting at a local government building. The governor or his director of reconstruction and development should discuss the latest PG plan for reconstruction and development. The basic concepts of road networks, district centers, and water should be covered. The plan can grow as the PG comes up with new ideas. The PRT can suggest some areas to cover based on the developmental stage of the province and the background of the PRT's USAID, U.S. Department of Agriculture (USDA), and DOS representatives.
- **Donor resource meeting.** It is best if the UN hosts this at its local headquarters because once again the PRT should not try to take the lead on reconstruction and development—other organizations are better suited to take the lead. At this meeting, donors provide information on what they are willing or able to provide in support of the PG's reconstruction and development plan. It is a good idea for the PRT to provide some basic security updates to the attendees because this is a good way to get donors to attend. This meeting is essential because it allows donors to identify parts of the PG's plan that they would like to support. In some cases, it is common for multiple donors to have already requested funding for the same reconstruction and development projects based on a lack of cross-coordination. This meeting helps the PRT gain a better appreciation for the capabilities and goals of various organizations. In turn, these organizations gain a better appreciation of what the PRT is all about and what it is able to do.
- **PRT provincial development meeting.** The PRT conducts an internal meeting to review the PG's plan and decide what is within their scope of reconstruction and development. This coordination meeting is important because it allows the PRT commander to get input from his staff on the feasibility of the PG's plan. This meeting also provides information the PRT commander needs for the donor resource meeting.

It is important that donors take away the same reference materials from the meetings when trying to coordinate resource distribution. Because many of the IOs/NGOs do not have the same maps as coalition forces, it is beneficial to provide reference material that is common to the PG and the donors. Some laws and policies may limit the ability to actually provide maps, but other information can be shared as a common reference. Assist in developing a baseline map COP. Overlay graphics displaying the existing key infrastructure/assets, active projects, planned

(funded) projects, planned (unfunded) projects, and active and planned (funded) projects should depict organization and delivery timetable.

Involving the PG

- Position PG at meeting.
- Getting the PG to set the agenda.
- Getting the PG to provide the meeting location.
- Getting the PG to advertise the outcome of the meetings.
- Getting the PG to request donors to come to the province.
- Transitioning practice to next PRT. The PRT must transition this meeting concept to the PG. The PRT commander must ensure that the new PRT commander understands that the PRT's role is as a donor. If the PRT starts taking a leading role in the meeting it will set back the entire process and make the PG dependent upon the PRT once again. Working toward developing sustainable systems means that the PG must run the show. With that said, the PRT must continue to work with the PG from behind the scenes to make the planning process more efficient and to create an effective advertising campaign for the PG's reconstruction and development plan.

Achieving success

This direct involvement of the PG ensures engagement of donors for planning and coordinating reconstruction and development. It increases the PG's and the PRT's knowledge of individual donor capabilities, goals, and resources. This type of meeting can lay the groundwork for development of productive, long-lasting relationships between the PG and its donors. The meeting helps to facilitate an understanding of the PG's reconstruction and development plan so that donors do not get distracted from creating their own unsynchronized plans. It can also accelerate reconstruction and development by reducing redundant efforts and achieving complementary efforts. The PG sees the gaps and seams in their plan because donors do not sign up to provide resources in certain areas. In time, the local government will assume responsibility for the reconstruction and development within the country, thus facilitating learning for the PG. As the PG gains credibility and confidence, the PRT can remove itself from the meetings. These meetings can create new relationships and dispel myths created by not knowing the other donors. As time goes on, the PG and donors feel more confident with each other, allowing partnerships to grow. The number of times NGOs/IOs volunteer to take on a project should increase. The NGOs/IOs will also start to share information with the PRT. Eventually, the PG takes over conducting the meetings.

Measures of effectiveness

- Number of times NGOs/IOs volunteer to take on a project the PRT cannot resource
- Amount of information NGOs/IOs share with the PRT

- Creation of any partnerships that were previously not welcomed
- PG taking over the meeting

Building Provincial Medical Capacity

How can the PRT assist the PG to build sustainable medical capacity in the province?

Everything from the way the PRT conducts its medical activities outreach program to the sourcing of medical supplies can have a positive or negative effect on the how quickly medical capacity is built in the province.

Two areas that have a particular impact are:

- Sub-practice 1: How the PRT works with provincial health officials and existing host-nation facilities to build in-situation capacity.
- Sub-practice 2: How the PRT plans, sources, and purchases medical supplies to support its medical capacity building in the province.

The PRT needs to purchase medical supplies frequently to provide support to host-nation clinics and augment collaborative medical outreach events. Medical supplies are hard to source through U.S. channels. However, hasty local sourcing of medical supplies presents a number of risks and could lead to negative effects. Negative effects include temporary shortages of medicines and/or increases in prices at local pharmacies. Other risks include sourcing of poor quality products (not meeting required quality specifications or medicines past their expiration date).

One PRT addressed this problem by developing a process to mitigate risks and successfully source frequently demanded medical supplies/products through local distribution channels.

- Plan projects well in advance and aggregate the purchasing volume into one sourcing event. The sourcing process could take up to 45 days.
- Build requirements based on inputs from multiple sources.
- Assess input from demand from previous events.
- Develop the technical specifications for required products.
- Develop a “request for quote” that includes the quantities, service level (e.g., delivery time), and packaging requirements.
- Screen and qualify potential vendors.
- Issue and manage request for quote process.
- Inspect the product thoroughly upon receipt, preferably by qualified or trained personnel.
- Properly store all medicines.

Suggested approach

Implementing steps:

- **Determine requirements.** Assess current and future demand for medical supplies. The PRT should estimate the number of village/township medical outreaches and collaborations with clinics or medical civic action programs that are planned over a longer time horizon and summarize the intermediate requirements for three to six months.
- **Develop a list of potential suppliers.** Screen potential suppliers in the province and beyond. Develop a long list of suppliers/distributors capable of supplying products and services of the required quality in the quantities needed.
- **Screen for potential suppliers distributors in the province and beyond.** Use available contacts in the province to identify sources of supply. These contacts include provincial directors, USAID, and other aid agencies working in the province. Make it clear that you are just certifying the suppliers. Develop information profiles for potential vendors for future purchases. Collect this information in a standard format.
- **Refine criteria selection requirements.** Refine requirements, supplier market coverage, distribution range, and order lead time.
- **Prepare a request for proposal.** Develop clear request for proposal that sets out the plan.

Continue to update assessment and communicate progress:

- **Reassess the PG.** This can be treated much like a U.S. conference. The PRT is going to provide the attendees with lodging and food to ensure there are reasons to stay for the entire six days of instruction.

Measures of effectiveness

- Number of qualified suppliers: screened by capability, product range, and basic service-level information
- Measured reduction in total system cost (product unit cost + transport/intratheater delivery, waste due to expired lots)
- Improved order lead time (over delivery time on standard orders); does not cover expediting due to poor event planning or inventory management).

Establishing a Provincial Trade School

How can the PRT assist the PG in developing a skilled labor force?

A locally trained, readily available workforce of skilled laborers is needed to help rebuild the local community and help maintain newly constructed buildings and roads. Trade schools may exist in larger urban centers. However, these schools may be too far away to serve the needs of the province. Each province needs local training to solve the skilled labor shortage. Students who leave for training often do not return. Workers from other countries or other provinces may fill the numerous skilled labor positions. Those host-nation citizens who do find work do not provide the job quality needed to meet long-term reconstruction goals and maintenance standards. The province needs an organic training center to meet current and future demands for skilled labor.

Success of this program will seed the province with a trained (semi-skilled to skilled) local labor force and increase its size. Because local laborers will be hired from the program, it will keep money in the province. This low-tech program is easy enough for the government to take over in the near term and expand to meet the needs of the province. This is also an opportunity for PG officials to work together and increase their trust of each other. Another positive result is the increased potential for job placement for graduates because of the high demand for local laborers.

Example: The way one PRT addressed this problem was through the creation of a vocational trade school that can train up to 250 local nationals concurrently. Currently, classes are held over a three-month period in the winter. Upon graduation, the students will have completed a local community project, received a basic starter tool kit tailored to their completed program of instruction, and be presented a certificate of completion. This certificate will be placed on file with the ministers of education and labor in order to maintain a list of trained laborers. The PRT continues to work with the minister of education and the governor to develop a plan that will provide classroom space and instructors for future trade school sessions. The next step is to assist the PG's plan and execute the creation of other vocational trade schools. The end result of these efforts is a small pool of trained employees who will be able to find local jobs and increase the quality of construction in the province as the PG works towards self-sustaining systems.

Suggested approach

To ensure that a coordinated effort is possible, PRT-selected programs should be led by a host national. All PRT personnel involved in the vocational trade school should assist in developing the curriculum. However, picking a program lead is the most important first step to coordinating PRT and PG efforts. The PRT commander and the program lead can meet with the governor and ministers of education and labor to pitch the trade school concept and get buy-in on the idea. The PG should agree that the province can take over the management of the school and extend the reach throughout the province before significant effort is provided. You can also attempt to gain a pledge from the PG that this would be a priority.

The PRT can work with the PG and other coalition resources to assess the skills most required in the province. For instance, a coalition facility engineer team (FET) observed that construction projects built by local workers were often of lower

quality than those built by workers from another country. Many contractors hired workers from outside the country because of their superior construction trade skills. The FET engineers suggested the most relevant construction trade skills that local workers were lacking.

Working with the minister of labor, the CAT-A team expanded an assessment of the province to determine the need for trained vocational skills. They discovered a demand for welders, masons, carpenters, plumbers, rug makers, and medical personnel. Additionally, due to the high demand for trained personnel, many of the students could have job opportunities waiting upon graduation. The PRT spoke with the PG and several local businessmen to locate potential local instructors. They found a local computer shop owner, welder, and auto mechanic. Additionally, the top graduates of the course could be identified, and the PG could consider using them as future instructors.

To identify instructors the PRT can conduct a skills inventory of all PRT Soldiers, interpreters, and interagency representatives. A basic list of classes can be created from this inventory internal to PRT assets. This list may consist of areas such as welding, plumbing, electrical, carpentry, auto mechanics, emergency medical technician, and basic computer skills. The instructors can be paired up with PRT interpreters. The Soldiers can develop a draft 12-week syllabus and turn it into the program lead for review and synchronization with the overall classroom schedule. The periods of instruction are meant to be basic in nature but yet able to increase the overall skills and quality of the workforce. Basic vocational trade techniques are the key to creating a successful program. Additionally, teachers can train the interpreters as teacher's aides to assist in the classroom. Techniques taught are tied to equipment that is available in the host country so they can be replicated easily by the students after graduation.

All instructors should develop a list of equipment needed to teach their classes. Additionally, instructors can develop a basic tool kit to provide to the graduates. For instance, a graduate of the welding class would be provided a welder's hood, apron, and gloves. The intent is to provide all the tools necessary so the graduate can easily be hired at a welding shop that already has a fuel tank, welding torch, and welding raw materials. The estimated cost of establishing a vocational trade school is about \$200,000 in Afghanistan and can vary based on location.

After assessing the PG's ability to provide immediate classroom space, it may be better to host the school at the PRT site because the PRT could better control the classroom schedule and provide security. Additionally, the opening of the school may be delayed without access to the PRT classroom space. The intent is for future semesters to be taught at locations other than the PRT site and be provided by the PG. Throughout the whole process, members of the PRT should coordinate all efforts with the PG to ensure unity of effort. The PRT should use this event as a teaching and mentoring tool to show the PG that it is possible for local officials to resolve a key issue important to both the PG and the local people.

Because this program is only partially created at this point, the PRT should work aggressively with the PG to ensure that the PG takes control of the trade school during the second semester. However, the PRT could easily transfer this program to the next PRT to continue as it tries to spread the concept throughout the province. However, the ability of the PRT to provide instructors is less likely the farther the program is from the security of the PRT.

Measures of effectiveness

The success of this program should be easy to measure. The number of trained graduates and those who immediately enter the local workforce will give a good indication of success. Outstanding graduates can be hired to teach at the school upon graduation. The creation of a second provincial trade school in a nearby district will increase capacity. Graduates can migrate to other provinces to gain temporary work and bring money back to the province where their family lives. With each successive class, the ministries of education and labor maintain a list of graduates who are eligible for government jobs. Other indicators of effectiveness include:

- The number of graduates (trained).
- The number of graduates that immediately enter the local workforce.
- The number of graduates hired to teach at the trade school.
- The creation of a second provincial trade school in a nearby district.
- Establishing a pilot trade school in a neighboring province where graduates with work experience start teaching.
- Graduates migrating to other provinces to gain temporary work and bringing money back to the province where their families live.
- The ministries of education and labor maintaining lists of graduates who are eligible for government jobs.

Establishing a Builder's Workshop to Improve Building Capacity

How does the PRT overcome a shortage of building trade skills and competent contractors in the province?

Contractors need to be trained as a team, outside a formal classroom setting. More trained and qualified contractors will accelerate the pace of quality construction and build a foundation for the provincial construction trades industry. Skilled training is needed to meet long-term reconstruction goals and maintenance standards and provide quality construction. The PG needs to train host national workers to build reconstruction and development projects to improve building capacity and help meet current and future demands for skilled labor.

The way a PRT can address this problem is by creating a workshop devoted to training its regular contractors on good construction techniques. U.S. Army engineers can train the national army engineers on quality building trade practices appropriate for a developing country. The national army engineers will then instruct the contractors. The course of instruction is the same course work given to the national army engineers. The contractors may bring along up to three workers each to receive the instruction. A set of good tools should be provided to students upon graduation. Graduates would receive a certificate of completion and a wallet-sized identification card saying they have completed this course. The PG can be represented by the MRRD and the provincial engineer. The next step is to conduct the class again and upgrade the skills taught to returning attendees. The end result

of implementing these practices is to create a small pool of trained employees who will be able to find local jobs. Having trained builders will increase the quality of construction in the province as the PG works towards self-sustaining systems.

Suggested approach

Coordinating the concept:

- **Selecting a program manager.** To ensure that a coordinated effort is possible, the PRT should select a volunteer to lead the program. The program manager can be a CAT leader who works directly with U.S. Engineers.
- **PG interest.** The PRT commander and the program lead should meet with the provincial engineer and the national army leadership to get buy-in on the concept. The meeting should be a basic concept discussion.

Conducting a provincial assessment:

- **Construction quality.** Assessments of provincial construction projects may not always be up to the quality standards required for projects to last. It has been suggested that projects constructed by host nationals are often of a lower quality than those built by workers from another country because of the skills gap. Sometimes all of the contractors may come from outside the province. To be truly effective the PRT should require that at least 75 percent of workers hired for projects come from the local district.
- **Existing vocational trade schools.** There may not be any trade schools existing in the province to teach proper construction techniques.
- **Job opportunities.** Each contractor should bring three attendees with him. The thought behind this is that the attendees who are not contractors may be able to start their own construction business as a result of this training.

Creating the workshop:

- **School location.** This can be treated much like a U.S. conference. The PRT is going to provide the attendees with lodging and food to ensure as much as possible that students attend the entire six days of instruction.
- **Developing a curriculum.** The CAT/PRT can choose to utilize the Inter-Service Builder Apprentice Training (A-710-0010) and Inter-Service Building Apprentice Training Phases A, B, and C (A-710-033 Army). This will ensure that the host-nation army trainers and contractors will have a good base of instruction.
- **Equipping the school.** The PRT/CAT can order quality tools from vendors. Part of the problem with local construction is that the tools often break and are not of good quality. Some of the contractors may be interested in becoming tool distributors.

- **Coordinating with PG.** Throughout the whole process, PRT members should coordinate all efforts with the PG to ensure unity of effort. The provincial engineer should be heavily involved in developing this plan. The provincial engineer could be a guest instructor during the workshop. He will provide the continuity necessary to continue the program.

Transitioning the school to the PG:

- PG provides classroom location.
- PG provides all classroom equipment.
- PG provides the graduation basic tool kits.
- PG provides local instructors and pays them.

Security Sector Reform

Provincial security coordination body

How does the PRT assist the PG in providing needed emergency services to the populace?

The PG identified the need for a 24/7 emergency operations center (EOC) to collect information and provide emergency services to the people. In the United States citizens take it for granted that the government will provide emergency services. Many countries do not have the same level of government services. Many provinces will have to build all of these services from the ground up because there are very few places where they exist.

One PG created a working security forum for elections. In doing so, they discovered a need for a permanent standing body of decision makers who could share information and synchronize security efforts. This group met weekly and was chaired by the provincial police chief at the national police headquarters. The attendees include a national army liaison officer (LNO), the deputy border police, a highway patrol representative, the deputy national director for security, the PRT S3, the maneuver S3, and a representative from the embedded training team (ETT). A 24/7 EOC was established from this collaborative effort. The PRT ensures that it brings several interpreters to the meeting to catch sidebar conversations. The PRT S3 shares the information with other coalition members who do not attend the meeting. The meeting is not classified and discussions only concern basic security information. The important thing to remember is that the PRT is only an invited member and does not run the meeting. Steps are being taken to have the PG provide this security information to IOs/NGOs so they are less dependent on the PRT for this information.

Suggested approach

As with most practices, it is important to select the right program lead. This will ensure that a coordinated effort is possible. In this particular case, the PRT selected the S3 to develop and monitor this program. The PRT commander and the program lead met with the governor and the provincial police chief to discuss the necessity for having a coordination meeting for security personnel in the province. This was

essential during the election process and has become a regularly scheduled meeting that continues into the non-election period. The governor gained great interest in this program based on his desire to create a 24/7 EOC as part of his provincial district center.

The key to success is becoming one of many sources of security information for the PG. By decreasing PRT responsibility, the PG provides the full security scope to those who need it. If the PG leadership is effectively using its national security force, they will be able to provide detailed information about corruption (illegal checkpoints, theft, illegally armed groups, etc.). This information can become part of the security information that the PG will provide during the PG donor meeting.

The incoming PRT S3 must be prepared to attend the meeting and not overstep the boundaries that have already been established by the previous PRT. It is essential that the PRT gradually takes a smaller role in the meeting to help establish PG responsibility.

Measures of success:

As the PG gathers/disseminates information impacting security, it will be less dependent on the coalition. The PG and the national security force will build stronger working relationships. The EOC will allow the PG to react to problems quickly and in a coordinated effort. As the PG's role develops, invited members will want to attend security forums to obtain and share information. The EOC will increase the PG's ability to react to security threats in a timely fashion. The ultimate success is a PG that handles all security issues independently. The following are signs that success is being reached:

- Continued attendance by all invited members to security forums
- Continued sharing of information by all parties
- Creation of a 24/7 EOC
- Ability of PG to react to security threats in a timely fashion
- Reduction in reliance on PRT and coalition forces for security assistance/information

Enhancing Provincial Tactical Advisory Team (PTAT) Effectiveness

How does the PRT employ the PTAT?

Provincial security is arguably the number one concern for everyone. Without security, it is difficult for the PG to effectively provide basic services to its people. Without a secure environment, donors are less likely to bring their much needed resources and leadership to the province. The PTAT provides the PRT with a means of reinforcing training already provided to the national police.

In the case of U.S.-controlled PRTs, the restrictions placed on CERP funds have caused many PRTs to reduce their interaction with the national police. However, there are some PRTs that have adjusted to the restriction of CERP funding for national police use and developed alternative interactions/programs that do not

require funding. These engagements are paying big dividends for the PRT and the provincial national police.

One PRT addressed this problem by assigning mentors to work with the provincial police chief and key leaders within the national police. Basic information about each police facility and police officer was collected and put into PowerPoint slides so the information could be displayed easily in the PTAT workspace. Inventories were conducted to gain an appreciation of the resources available at each police substation. Police substations within the area of operation (AO) are visited weekly to foster relationships.

The key to success is to consistently engage the national police. A basic task organization chart was developed that showed all the substation commanders. This allowed relationships to form between coalition forces and the national police that are deeper than just knowing someone's name. The time invested by the PRT paid off because the national police felt comfortable working with the PRT. The national police grew to understand that they were not able to get resources from the PRT, but that they could get ideas and refresher training, which makes it worth everyone's time. The relationships that have been created are far-reaching because the national police become a fully functioning partner in the law and governance of the province.

Suggested approach

Coordinating the concept:

- **Selecting a program manager.** To ensure a coordinated effort, the PRT should select the PTAT team leader to implement and monitor this program. If there is no PTAT team, selecting a senior individual with management experience for the program manager position is more desirable than selecting someone with only police experience. The Regional Training Command (RTC) is tasked with teaching policing skills. However, what the national police really needs is senior-level mentorship. Use of contract mentors may be another option to be employed, but they may not have the necessary management skills.
- **PG interest.** Often, the PG is only looking for resources such as vehicles, radios, and new construction. Because the PRT has limited funding and resources restrictions, mentorship is an effective and cost-efficient way to influence the national police. Resource limitations/restrictions of the PRT must be explained to the governor and the provincial police chief.

Conducting a provincial assessment:

- **Getting to know your AO.**
 - Document the task organization of the provincial national police by building a chart that has pictures, names, locations, and biographies of the police leadership.
 - Identify the location of national police buildings by Global Positioning System (GPS), as well as any hard stand checkpoints.

- Identify the location of the PG's RTC. If the RTC is not located within the province, acquire an understanding of how the province's national police obtain training seats and what actual instruction is received at the training center.

Getting to know the local police force:

- **Ensure that the PTAT conducts regular visits to local police substations.** Ideally, each substation should be visited twice a week. For district substations, coordinate to have the provincial police chief go with PRT patrols and stop in at various substations along the way to conduct assessments and engage the district police. Taking the provincial police chief is essential so he is viewed as an involved leader who cares about his police force. It also allows him to describe what he sees to the other members of the PG.
- **It is important to recognize that corruption exists in the police force.** Regardless, it is still essential that members of the PRT engage the police force on a regular basis. Hopefully, a foundation of managers can be found who are honest and easy to work with in order to overcome any corruption. Documenting corruption and bringing it to the attention of the governor is necessary so possibilities for leadership changes can occur.

Working with and instilling pride in the local national police:

- **Hold a parade.** To increase local awareness about the police force, the PRT should encourage the governor to show off the provincial police force. Having the national police wear their uniforms and show off new equipment in a parade in the capital is extremely effective.
- **Accountability of new equipment.** With the arrival of new equipment like AK-47s and vehicles, it is essential that the national police establish and maintain a system of equipment accountability. Teaching the national police to conduct inventories is essential in helping them understand that the equipment is not a gift to the individual user but belongs to the local police substation.
- **Culturally it is common for government employees to take home equipment that was originally provided to them to conduct their job.** This becomes extremely costly when vehicles, phones, and other high-priced equipment are retained by employees who no longer work for the government. One means to counter this practice is to have the PTAT work with the police chief to establish a radio room at each of his substations. The intent is to require officers to pick up their radio at the beginning of their shift and turn it in once they are done for the day. This teaches two key concepts: accountability and maintenance.
- **Holding a best police officer competition.** One PRT is working with the governor and the provincial police chief to hold a "Best Police Officer" competition that will include physical and mental challenges. The desired outcome is that units will increase their training efforts to win the competition. Certificates will be provided to the winner which is a motivating factor for the national police.

- **Conducting training and providing certificates of completion.** It is important to assess the skills of the national police and to work with the provincial police chief to conduct refresher training. However, prior coordination with the local RTC is essential to ensure that the techniques trained match those being taught at the RTC. In an effort to move out of the training role, it is necessary for the PRT to work with the governor and the provincial police chief to develop a training team to travel around the province to assess local police capabilities and conduct training as necessary. Providing certificates of completion from the provincial police chief is another way to instill pride in the local police and create a method of tracking training statistics.
- **Identifying a need for new training blocks of instruction.** After assessing that the national police did not fully understand how to handle improvised explosive devices (IEDs) that were turned in to local authorities, one PRT established a block of instruction that included pictures and the basic safety procedures for dealing with IEDs. It should be common for national police to pick up these devices after cutting all the wires and then bring them back to their headquarters or the PRT site for disposal. Some accidents occurred during IED removal by the national police which necessitated this class.
- **Including the national police in mission planning and patrols.** It is an excellent idea to include the national police when the PRT conducts missions and patrols. This practice has several advantages. First, it provides hands-on experiences that the national police can use to improve their ability to react to various situations. Second, the national police will be seen in a proactive role rather than sitting passively at their substations. Third, the national police can help the PRT reduce the coalition footprint in patrols by providing security for PRT missions. Fourth, the national police can become a communications multiplier as PRT patrols work their way through towns and villages where they have not been before. Including national police in planning and patrols can all be achieved by engaging the provincial police chief and gaining his support in this endeavor.

Involving the provincial governor:

- **Engaging the PG leadership.** The PRT commander and the program manager should conduct regular meetings with the governor and provincial police chief to provide feedback from assessments on the police force. Information should be shared at the Provincial Security Coordination Body, which is another measure of national police effectiveness in the province.
- **Working toward sustainability.** It is essential that the governor achieves an understanding of his police force's shortcomings so he can address them quickly. The national police are the first line of defense—without it law, governance, and security cannot be maintained. Without security, reconstruction and development continuation will not be possible. The PRT commander must constantly work with the governor to find ways to provide resources to the national police so that they do not quit or become corrupt.

- **Transitioning practice to the next PRT.** The PRT must continue to engage with the national police and provide mentorship to the governor and the provincial police chief. Abandoning this practice will potentially have a negative impact on security conditions in the province which will impact the areas of law, governance, and reconstruction and development.

Measures of success

- Assessments of the substations show improvement over time.
- National police maintain accountability for their property.
- Local citizens gain more confidence in their police force.
- National police are able to properly react to local crimes.
- National police attend the RTC and conduct refresher training.

Coordinating PRT Operations With National Security Forces (NSF)

How does the PRT ensure that its operations are coordinated with NSF?

NSF should have habitual relationships with the joint task force (JTF) maneuver forces and ETTs. By establishing and maintaining relationships with the ETTs and JTF maneuver units, the PRT can coordinate and leverage NSF capabilities in support of its missions. Coordinating to have NSF units provide local security for PRT missions enhances both the NSF and the PRT by providing a host-country face to mission security.

One PRT addressed this problem by coordinating its missions with the local JTF maneuver unit and the ETT assigned to local NSF. Coordination with these units of upcoming missions can include NSF in PRT operations where possible. This augmentation from the NSF helps reduce the coalition footprint on convoys and also validates the legitimacy of the NSF for people in remote towns and villages.

Suggested approach

Coordinating the concept:

- **Selecting a program lead.** The PRT program manager should be the S3. The PRT S3 is responsible for direct coordination with the nearest ETT and JTF maneuver unit to gain access to the NSF.
- **PG interest.** Most PGs do not concern themselves with the activities of the NSF. Working to enhance this relationship through the ETT or maneuver unit will also add to the province's security efforts.

Coordinating for NSF support:

- **Including NSF in mission planning.** The PRT S3 should work all planning issues with the ETT and/or maneuver unit so they can work the mission planning cycle with the assigned NSF unit. This is a great

opportunity for the NSF to conduct missions that provide them visibility within the local community and enhance their prestige within the country.

- **Force protection.** Several techniques were found for utilizing NSF on missions and patrols. The NSF are good at providing route security as well as taking control of situations that develop in remote villages and towns not familiar with the mission of coalition forces. The NSF are also very good at providing security for PG officials who are attending *shuras* where the PRT is also in attendance. This practice is very effective because it puts nationals in charge of the event and has the PRT in support.
- **Including NSF in military training.** PRTs with mortars can coordinate with the ETT to have the NSF conduct calls for fire drills that support live fire missions done to test the PRT mortars. These drills are often done monthly to provide training for the PRT mortar section.
- **Transitioning practice to the next PRT.** The PRT commander should explain the advantages of having NSF augment missions and patrols. Not using opportunities to work with NSF can put additional strains on available coalition manpower.

Measures of success

- Local citizens gain more confidence in the NSF.
- NSF takes over patrolling areas previously patrolled by coalition forces.
- Crime and anti-coalition militia (ACM) actions decrease over time due to NSF actions and presence.

PRT Management

Information Sharing

How does the PRT share information with its staff and higher headquarters?

The PRT requires practical information collection and display tools to provide a common understanding of the situation in the province. Current information graphically displayed enables better operations planning and reconstruction and development. Lack of transition data by relief in place (RIP) units causes a need to collect data about the province. PRTs use different methods of collecting and displaying data.

The PRT needs a system for collecting and storing data that makes the information available to different members of the team. The COP is the visual display that results from setting priority information requirements, developing workable processes for collection, and updating the graphic display to summarize information.

Suggested approach

- **Select a program manager.** The PRT S2 is probably the best choice to be the program manager; however, the PRT commander must ensure that the S2 does not solely rely on his mission to collect tactical data. The key to a successful COP is to include all members of the PRT (USAID, DOS, USAD, CAT, CMOC).
- **PG interest.** Teaching the provincial governor about the usefulness of having a reconstruction and development COP would be beneficial; however, based on limitations in technology in the province, using maps and overlays is probably the best implementation method of this practice.

Developing the parameters of the COP:

- **Deciding what data to collect.** The PRT S2 should hold a meeting with USAID, DOS, USDA, FET, PTAT, and any other member of the PRT who has an interest in data collection. An assessment sheet should be developed from this meeting that synchronizes the collection efforts of all PRT members.
- **Determining what system to use to display the collected data.** With today's technology it is possible to collect data in a database and display that information using graphical overlays on a basic set of maps. The old-school method of using a map with overlays can be effective; however, it is not as easy to query the data that is collected in reports created in Microsoft Word.
- **Using a shared drive and establishing a standard naming convention.** Rather than storing data under a personal logon, PRTs are setting up naming conventions for storing documents and keeping them on shared drives that can be backed-up weekly. Some PRTs need assistance in procuring external hard drives to create these backups. Standardizing this practice should be considered by higher headquarters. This standardization will help with retaining information that seems to be constantly lost as people depart the theater.

Visual techniques:

- **FalconView.** This program allows the PRT to create multiple overlays and digitally lay them over a standard set of maps. The system requires each piece of data to get plugged in with a GPS grid but does not allow the user to query the system to see trends.
- **ARC View.** Similar to FalconView, but this program allows for categorizing data. That enables the user to develop trend maps to see key relationships between events. One PRT is currently using this technique with great success. This system requires having users who know how to categorize the data to make it useful to a decision maker. The key to success with this system is consistent data entry.
- **WebTAS.** This system is currently under development. One PRT is serving as the test site for implementation. WebTAS allows the PRT to

create standard assessment forms that store information and allows the user to create multiple overlays and digitally lay them over a standard set of maps. The system requires each piece of data to get plugged in with a GPS grid but does not allow the user to query the system to see trends. Bandwidth is a limitation for using WebTAS.

- **Digital Battle Captain.** This system is probably going to be the most useful COP program once it is fully developed. It includes daily event data collected from multiple sources across the combined joint operational area (CJOA). However, the bandwidth at many locations will be a limitation.
- **Maps and overlays.** Although this is a basic system, it gets the point across by using a limited number of overlays and color codes. In the absence of any other visual capability, this is a great option.
- **Microsoft PowerPoint.** This is a low-tech way of displaying limited amounts of data. However, with the “build” feature you can show what was done in the past, present, and future. You can also display information about key personalities and make personality cards that servicemembers can carry with them on patrols. Once the baseline charts are created PowerPoint is easy to update. It does not have any query capability.
- **Microsoft Word documents.** This is the most used, but least preferred method because it only creates a large amount of text data that cannot be easily queried. It forces new arrivals to read through all the data to pick out what they think is useful. This takes a new team a lot of time to gain operational knowledge of the province and tends to cause the loss of data over time.

Limitations:

- **External hard drives.** The amount of storage space required is extremely large when using better types of software. External hard drives are also very useful for PRTs to backup their data rather than trying to do it on CD-Rs. Storing map sets on external hard drives can help with bandwidth issues.
- **Bandwidth.** Many of these data systems require data to be maintained at locations with limited amounts of bandwidth. As a result, the practical use of these automated systems is reduced, if not totally diminished, because it takes too long to get the data.
- **Plotters.** Currently, PRTs do not have the equipment needed to print large-scale copies of their COP, even if they have the software to create one. Some PRTs have started requesting production of their large-scale products off-site; however, this often very time-consuming. One PRT has a geographic information system (GIS) section working at the PRT with a plotter and appropriate software. They can produce almost any product within hours of a request. An investment in a GIS section and plotter would be a worthwhile investment.

- **Software.** Based on the large number of software packages available and the cost involved in buying them, it would be extremely beneficial if the CJTF or geographic combatant commander would pick a standard package and purchase it for everyone. Training and technical support are required to support the system. Feedback from the field is necessary to keep the system relevant.
- **Operators.** There are limited numbers of trained operators on the useful software packages described above. Without a dedicated trained operator, expectations of the actual usefulness of these systems are not realistic. Standardized data collection is the key to making these systems work. Without trained personnel, it is often better to just fall back on less technical methods of collecting and displaying data. However, the long-term usability and scalability of these low-tech methods is limited.

Involving the provincial governor:

- **Collecting data from the PG.** It is essential that the PRT have a copy of the governor's reconstruction and development plan. These data points should be put on a map to show how the province will progress in the future. Historical reconstruction and development data is important to allow the PG to see progress and for PRTs to see what has been accomplished in the past.
- **Sharing the COP with the PG.** Developing a reconstruction and development COP and sharing it with the PG and other donors is essential because the military has the best map-making equipment in the country. Often, the lack of maps (or the use of different maps) causes the PG and donors to misunderstand each other because the actual location of a reconstruction and development project is not known.

Transitioning practice to the next PRT: Ensure during the RIP that new PRT members are trained on the system used to develop the COP and that they fully understand how to maintain the data and why it is important. This common reference is essential to keep things running smoothly, as well as to ease future transitions. This system can be shared during predeployment site surveys allowing units to start training on the system and have relevant data before they arrive in theater. It also helps for new arrivals to have a basic understanding of their AO.

Transitioning practice to the provincial governor: One PRT developed the idea to have the provincial governor hire a local company to provide basic products that are developed from COP items. This company would be responsible for conducting surveys in each district and tabulating the data into information the PG found relevant and essential to the decision-making process. By doing this, the PRT would have COP products that the PG could hand out at the PG donors meeting, as well as use during the Provincial Security Coordination Body. These basic products would not cover everything that the PRT needs, but it would be a way to get the PG to make decisions based on raw data.

Measures of success

- Improvement in cross talk between PRT members
- Smoother in-processing of new personnel
- Reduction in the amount of redundant data input
- Historical data captured in a usable manner

Coordination With Other Units

How does the PRT coordinate reconstruction and development activities with other units?

PRTs require practical information collection and display tools to provide a common understanding of the situation in a particular province. Graphically displaying current information enables better operations planning and reconstruction and development. Lack of transition data by the RIP unit causes a need to collect data about the province.

Within the CJOA, maneuver units own all of the PRT operational environment. Lines of command can become blurred without higher headquarters clearly defining who is in charge. In instances where the PRT and a maneuver unit are collocated, the maneuver commander is the senior commander. In most of these instances the PRT operates at a reduced level of manpower, because it is collocated with a maneuver element. However, the difference in missions between the two units can make both parties ineffective without properly coordinating operations. If the PRT is not collocated with a maneuver element and has its full complement of force protection, it is still essential to know what other operational elements are doing in the province.

Suggested approach

The maneuver element S3 host a weekly meeting that includes the PRT and any maneuver elements in the AO. The meeting is essential because it allows all elements to deconflict their operations over the next week, as well as provide support when something happens that requires emergency assistance. The meeting also allows all parties to share information that others might find irrelevant; however, since attendees may be working in different parts of the province and/or working with different people, they ultimately will have information to share that all will find important. The meeting also allows units to find gaps and seams that can be mitigated to help share limited resources. Some future steps in this process would be to include the host government security force so it can learn how to conduct such a meeting and synchronize data sharing. This can all be integrated back into the 24/7 EOC.

Coordinating the concept:

- **Selecting a program lead.** The PRT S3 is the best person to be the program lead. The CAT-A team leader might want to attend to gather information firsthand from the meeting.

- **PG interest.** This meeting has no primary use to the PG; however, information from it could be used by the maneuver element and the PRT to assist them at the Provincial Security Coordination Body.
- **Conduct of the meeting.** The maneuver S3 hosts the meeting at his location and sets the weekly agenda. Attendees include the maneuver S3, PRT S3, ETT, and any other coalition force representatives in the province. All invitees must be able to review their missions and patrols for the next two weeks so a COP of events can be determined and deconflicted. When the maneuver element and the PRT are collocated, more time should be spent coordinating missions and patrols because the maneuver element must provide force protection in order for the PRT to accomplish its mission. This requirement for force protection can be greatly impacted if the maneuver commander has a different plan and is relying on these same limited resources.
- **Transitioning practice to the next PRT.** Review the meeting agenda with the new personnel and cover the due-outs for the next meeting. Also, provide historical meeting notes to show the intent of the meeting and its usefulness.

Measures of success

- Reduction in the duplication of missions and patrols
- Sharing of resources to supplement PRT missions and patrols
- Better working relationship with the maneuver element
- Mutual increased respect and understanding of all stakeholders
- Improvement in cross talk between PRT members
- Smoother in-processing of new personnel
- Reduction in the amount of redundant data input
- Historical data captured in a usable manner

Extending the Reach of the PRT Using Remote Patrol Bases

How does the PRT reach outlying districts within its province?

By design, PRTs are located close to the provincial capital. In many cases this limits their ability to reach all of the districts of the province on a frequent basis. Because many countries have a relationship-based culture, the absence of anything close to a regular presence puts any new relationship at a risk.

One PRT addressed this problem by establishing three remote patrol bases within the province to help project the presence and impact of the PRT. The patrol bases are located in safe houses, guarded full-time by hired security forces or collocated on a national police compound. The patrol is commanded by a major with about a 20-person organization and staffed with other PRT skill sets as required. The patrol leader constantly engages the local population and collects information for the PRT.

The remote patrol base concept allows relationships to form and grow with the local population. It also allows the PRT to make regular assessments and conduct quality control checks on remote projects. Patrols stay out for about three weeks at a time and then return to the PRT site for resupply. The same people return to their remote patrol base to ensure relationships are maintained with the locals. Because many of the remote locations are snowed in during the winter, the PRT shuts down the patrol bases except for the local security force. The PRT also reduces its staff in the winter months when the location of the remote bases is not trafficable.

Suggested approach

- **Location of remote patrol bases.** Selection of remote patrol base locations should be based on where they can have the most impact on the local population.
- **Manpower.** The PRT started with 120 people. This larger size allows for the manning of remote patrol bases; however, there is a manpower savings in the winter months when the remote patrol bases shut down until the spring thaw.
- **Transitioning practice to the next PRT.** This is a very easy concept to replicate if prior planning is done and teams are formed early. The new PRT members are identified early enough so that they can form as a team and participate in a three-phased approach. Throughout this process the current PRT members are in frequent contact with the new team before arrival. The three phases consist of a two-week predeployment site survey, a five-week PRT specific train-up, and a two-week left-seat/right-seat ride.
 - Phase 1: The key leaders in the PRT come to the host country and spend two weeks experiencing and learning about the specifics of the province. They do not spend their time learning about how to do things inside the PRT infrastructure. They concentrate on learning about the PG's vision and the influential people in the province. From this experience, they are able to take back information that is essential for Phase 2.
 - Phase 2: The entire PRT comes together at a training site where they focus on how a PRT functions and works together. PRT members spend time learning about the province; local and key leaders; and the situation in the province, both past and present.
 - Phase 3: The entire PRT arrives and spends two weeks together learning their jobs firsthand. There might be a few gaps in areas like cooks and administrative personnel; however, the key players (e.g., CAT, FET, and force protection sections) all spend time with each other learning how to implement what they have learned in their previous train-ups. This practice allows for more cohesive PRTs. PRT members practice meeting with the key and local leaders and getting the patrols out to their patrol bases to meet with the people. This is a well-planned engagement, with time spent getting to know the people and maintaining relationships, which is important in Middle Eastern cultures.

Measures of success

- Increased data collection from the districts
- Increased quality of construction projects based on the amount of time spent conducting quality control
- Willingness of locals to welcome the return of remote patrol bases during lulls or redeployments because of continuous relationship building
- Better able to counteract anti-coalition sentiment

Preparing the PRT for Local and National Engagements

How does the PRT ensure that its members conduct themselves properly when conducting engagements?

Not all personnel assigned to the PRT possess the tools and skills necessary to successfully engage the people or the provincial governor.

The PRT commander constantly stresses the importance of being security conscious while still being aware of properly interacting with the local population. Although no formal training process has been established, keeping the purpose of the mission at the forefront of most discussions makes servicemembers take this into consideration during mission planning and execution. Ensuring that everyone on the mission knows what they are going to be doing helps all to understand their part. Force protection Soldiers should be rotated through the tactical operations center (TOC), guard towers, and missions outside of the wire to get a better appreciation for what the PRT is doing and to gain an understanding of the nation's people and culture.

Suggested approach

- **Leader meeting.** The PRT commander holds a leader meeting where the commander engagement concept is outlined. The PRT is to keep security on the forefront of all planning; however, adverse risk is not going to be an option. Steps are taken to ensure that a friendly appearance is presented when possible. Examples of this behavior are reducing vehicle speeds when driving through town and waving to the people. Additionally, the posture PRT personnel take with their weapons when on patrols is dictated by the perceived ACM threat in the area.
- **Conducting informal training.** Because PRT operations are often new to many servicemembers, on-the-spot corrections are common; however, covering this during mission briefs keeps it on the forefront of their minds. Additionally, the PRT works to get everyone involved in local engagements on a routine basis. This means occasionally getting force protection personnel out of their vehicles during an engagement to attend a *shura* or a local meal as a participant rather than a security element. PRTs also rotate all personnel through the TOC to gain a better understanding of mission planning.

- **Conducting formal training.** The PRT intends to develop some formal periods of instruction that will put everyone on the same level of knowledge of the following:
 - **PRT mission.** This is more than just the standard mission. Each PRT member's mission should be covered in detail, including techniques for successfully interacting with the local populace. This instruction might even cover some of the COP data that the PRT is looking to collect while performing its everyday missions.
 - **Risk avoidance versus risk mitigation.** It is possible for a PRT to get into the habit of reducing the amount of time they leave the wire because of risk avoidance. If PRT members do not leave the wire, they are not able to engage with the PG and the local people; therefore, they cannot conduct their mission. Risk mitigation is taking steps to reduce potential security hazards in order to continue to accomplish the mission.
 - **Government structure.** Lessons on how the government was formed, how PG officials are elected or selected for positions, and information on the background of the constitution are important. Understanding these subjects is critical in avoiding embarrassing errors.
 - **Religious practices and the mullahs.** Understanding the religious practices of host nationals helps servicemembers figure out why locals make certain decisions. Many people do not understand how mullahs can be so influential in the PG's decision-making process. Working with cultural experts, reading material about Islam and talking with local citizens can help servicemembers gain a better appreciation of the local culture.
 - **Adopting a local village.** After getting to know the local people, some PRTs have adopted a local village. Donors from the United States send items that servicemembers can share with the local population. This is an effective way to create a bond with little effort or expense.
 - **Sporting events.** Because many of the local kids like to play soccer, one PRT set up a challenge against a local soccer team. The national police provided security for the event, which turned out to be a great success. Members of the PG may attend the event and hand out an award at the end.
 - **Teaching culture.** One PRT helped its local guards to improve their English skills. The PRT had several of the guards talk about life in their country and their religion with servicemembers. Many of the local guards are close in age to the young PRT members. Because of the relationship the PRT members already have with these guards, hearing about the local life and culture from them will have more of an impact than from an instructor the PRT members do not know.

CENTER FOR ARMY LESSONS LEARNED

- Transitioning practice to the next PRT: Members of the PRT should share their experiences with new arrivals to reduce their anxiety level. Ultimately, anything PRT members can do to help the next PRT understand the local population will help.



Center for Army Lessons Learned (CALL)
10 Meade Avenue, Building 50
Fort Leavenworth, KS 66027-1350

U.S. UNCLASSIFIED